



NC DEPARTMENT OF
**HEALTH AND
HUMAN SERVICES**

ROY COOPER • Governor

MANDY COHEN, MD, MPH • Secretary

MARK PAYNE • Director, Division of Health Service Regulation

VIA EMAIL ONLY

March 17, 2021

Robert A. Hamill

RHamill@hallrender.com

Exempt from Review – Replacement Equipment

Record #: 3504
Date of Request: February 19, 2021
Business Name: North Carolina Radiation Therapy Management Services, LLC
Business #: 2124
Project Description: Replace existing linear accelerator
County: Wayne

Dear Mr. Hamill:

The Healthcare Planning and Certificate of Need Section, Division of Health Service Regulation (Agency), determined that the above referenced project is exempt from certificate of need review in accordance with G.S. 131E-184(a)(7). Therefore, you may proceed to acquire without a certificate of need the Elekta Versa HD linear accelerator to replace the Varian Clinac 2100C linear accelerator. This determination is based on your representations that the existing unit will be sold or otherwise disposed of and will not be used again in the State without first obtaining a certificate of need if one is required.

It should be noted that the Agency's position is based solely on the facts represented by you and that any change in facts as represented would require further consideration by this office and a separate determination. If you have any questions concerning this matter, please feel free to contact this office.

Sincerely,

Gregory F. Yakaboski
Project Analyst

for
Lisa Pittman
Acting Chief, Certificate of Need

cc: Radiation Protection Section, DHSR
Construction Section, DHSR

NC DEPARTMENT OF HEALTH AND HUMAN SERVICES • DIVISION OF HEALTH SERVICE REGULATION
HEALTHCARE PLANNING AND CERTIFICATE OF NEED SECTION

LOCATION: 809 Ruggles Drive, Edgerton Building, Raleigh, NC 27603
MAILING ADDRESS: 809 Ruggles Drive, 2704 Mail Service Center, Raleigh, NC 27699-2704
<https://info.ncdhhs.gov/dhsr/> • TEL: 919-855-3873

AN EQUAL OPPORTUNITY / AFFIRMATIVE ACTION EMPLOYER



Hall, Render, Killian, Heath & Lyman, LLP
Perimeter Three
3015 Carrington Mill Blvd.
Suite 450
Morrisville, North Carolina 27560

Robert A. Hamill
(919) 447-4970
rhamill@hallrender.com

February 19, 2021

VIA EMAIL

Martha Frisone
Chief
North Carolina Division of Health Service Regulation
Healthcare Planning and Certificate of Need Section
809 Ruggles Drive
Raleigh, NC 27603
Martha.Frisone@dhhs.nc.gov

RE: Replacement of Linear Accelerator at 2802 McLamb Place, Goldsboro, NC 27534

Dear Ms. Frisone:

We represent North Carolina Radiation Therapy Management Services, LLC (“**NCRTMS**”). We are writing to inform the North Carolina Department of Health and Human Services, Division of Health Service Regulation, Health Planning and Certificate of Need Section (“**CON Section**”) of NCRTMS’ intention to replace the linear accelerator that is currently in operation at 2802 McLamb Place, Goldsboro, NC 27534 (“**Existing Equipment**”). For the reasons explained below, NCRTMS’ replacement of the Existing Equipment is exempt from certificate of need (“**CON**”) review pursuant to N.C. Gen. Stat. § 131E-184(a)(7).

1. **Description of Equipment.**

The Existing Equipment is a Varian Clinac 2100C. A description of the Existing Equipment’s features and capabilities is attached hereto as Exhibit A. The Existing Equipment was acquired by NCRTMS as refurbished equipment in 2011. The Existing Equipment has been in operation at Wayne Radiation Oncology, a division of Radiation Therapy Associates of Western North Carolina, since that time, and is used to provide radiation therapy for the treatment of cancer. Upon replacement, the Existing Equipment will be moved out of state and disposed of.

NCRTMS intends to replace the Existing Equipment with a new Elekta Versa HD linear accelerator acquired from Elekta (“**Replacement Equipment**”). The Replacement Equipment will be used to provide the same radiation treatment to cancer patients as the Existing Equipment. The Replacement Equipment will have the same technology as the Existing

Equipment, will be functionally similar to the Existing Equipment, and will be used to provide the same cancer treatments to patients. A description of the Replacement Equipment's features and capabilities is attached hereto as Exhibit B. The acquisition of the Replacement Equipment will not result in more than a 10% increase in patient charges or per-procedure operating expenses within the first 12 months following acquisition. NCRTMS' total cost to acquire the Replacement Equipment is estimated to be approximately \$1,958,550.00. A summary of the costs to acquire and install the replacement equipment is attached hereto as Exhibit C. Documentation supporting those costs is attached hereto as Exhibit D.

2. **Overview of Applicable Law.**

"Replacement equipment" is exempt from CON review. N.C. Gen. Stat. § 131E-184(a)(7). "Replacement equipment" is equipment that costs less than \$2,000,000 and is purchased for the sole purpose of replacing comparable medical equipment currently in use which will be sold or otherwise disposed of when replaced. N.C. Gen. Stat. § 131E-176(22a). The cost of the equipment, studies, surveys, designs, plans, working drawings, specifications, construction, installation, and other activities essential to acquiring and making the equipment operational shall be included when calculating the total cost of replacement equipment. *Id.*

Replacement equipment is comparable to the equipment being replaced if: (i) it has the same technology as the existing equipment, although it may possess expanded capabilities due to technological advancements; (ii) it is functionally similar and used for the same diagnostic or treatment purposes and is not used to provide a new health service; and (iii) the acquisition of the equipment does not result in more than a 10% increase in patient charges or per-procedure operating expenses within the first 12 months after replacement. 10a N.C.A.C. 14c. 0303(d).

Replacement equipment is not comparable to the equipment being replaced if, among other reasons: (i) the replacement equipment is new or reconditioned, the existing equipment was purchased second-hand, and the replacement equipment is purchased less than three years after the acquisition of the existing equipment; (ii) the replacement equipment is new, the existing equipment was reconditioned when purchased, and the replacement equipment is purchased less than three years after the acquisition of the existing equipment; or (iii) the replacement equipment is capable of performing procedures that could result in the provision of a new health service or type of procedure that has not been provided with the existing equipment. *Id.* at (e)(1)-(3).

3. **Analysis.**

The Replacement Equipment constitutes "replacement equipment", as defined under Section 131E-184(a)(7), and is therefore exempt from CON review for the following reasons:

- a. The total cost of the Replacement Equipment is less than \$2,000,000;
- b. The Existing Equipment will be removed from the state and disposed of;

- c. The Replacement Equipment has the same technology as the Existing Equipment;
- d. The Replacement Equipment is functionally similar to the Existing Equipment, will be used for the same treatment purposes, and will not be used to provide a new health service;
- e. The acquisition of the Replacement Equipment will not result in a 10% increase in patient charges or per-procedure operating expenses within the first 12 months; and
- f. While the Existing Equipment was reconditioned when purchased and the Replacement Equipment is new, the Replacement Equipment is being purchased more than three years after the acquisition of the Existing Equipment, and the Replacement Equipment is not capable of performing procedures that could result in the provision of a new health service or type of procedure that has not been provided with the Existing Equipment.

On behalf of NCRTMS, we respectfully request that the CON Section provide written confirmation that NCRTMS' replacement of the Existing Equipment with the Replacement Equipment, as described herein, is exempt from CON review pursuant to N.C. Gen. Stat. § 131E-184(a)(7).

Please do not hesitate to contact me if you have any questions or require additional information. Thank you for your review and consideration of this matter.

Sincerely,

HALL, RENDER, KILLIAN, HEATH & LYMAN, LLP



Robert A. Hamill

Exhibit A
Existing Equipment

[See Attached]

VARIAN

medical systems

INSTALLATION DATA PACKAGE

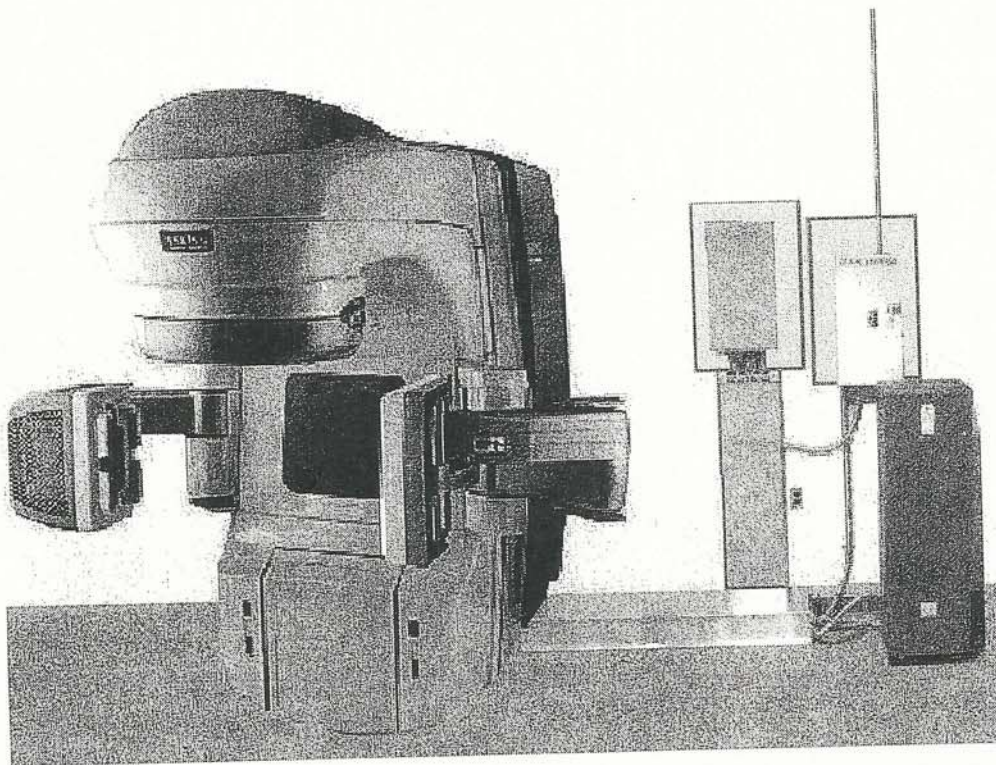

On-Board Imager (OBI) Upgrade for
Clinac 2100C/D, 21EX To S/N 2799
Clinac 2300C/D, 23EX To S/N 499
Equipment Information

English Version
October 2007

Conduit Length Worksheet (OBI Upgrade)



DATE: 11/18/2008

TO: David Gruzlewski, Project Administrator

FROM: Mark Vaughan, Project Manager

RE: Conduit lengths

To manufacture cables for your Clinac, we need a measurement of the as-built conduit or trough length per the diagram below. Your electrical contractor should provide these measurements. Report only the longest measured run of the conduit set. Gathering this critical information is your responsibility.

Additionally, record the distance from the console pull-box to the location of the Varian console electronics cabinet. In some cases, this distance will greatly affect the cable lengths.

Cable orders require a three-week lead-time for delivery. Please email or fax your measurements to me at the location indicated at the bottom of this page as soon as possible.

The diagram below is a generic representation of a treatment room used to indicate the points of measurement. It is not specific to your project.

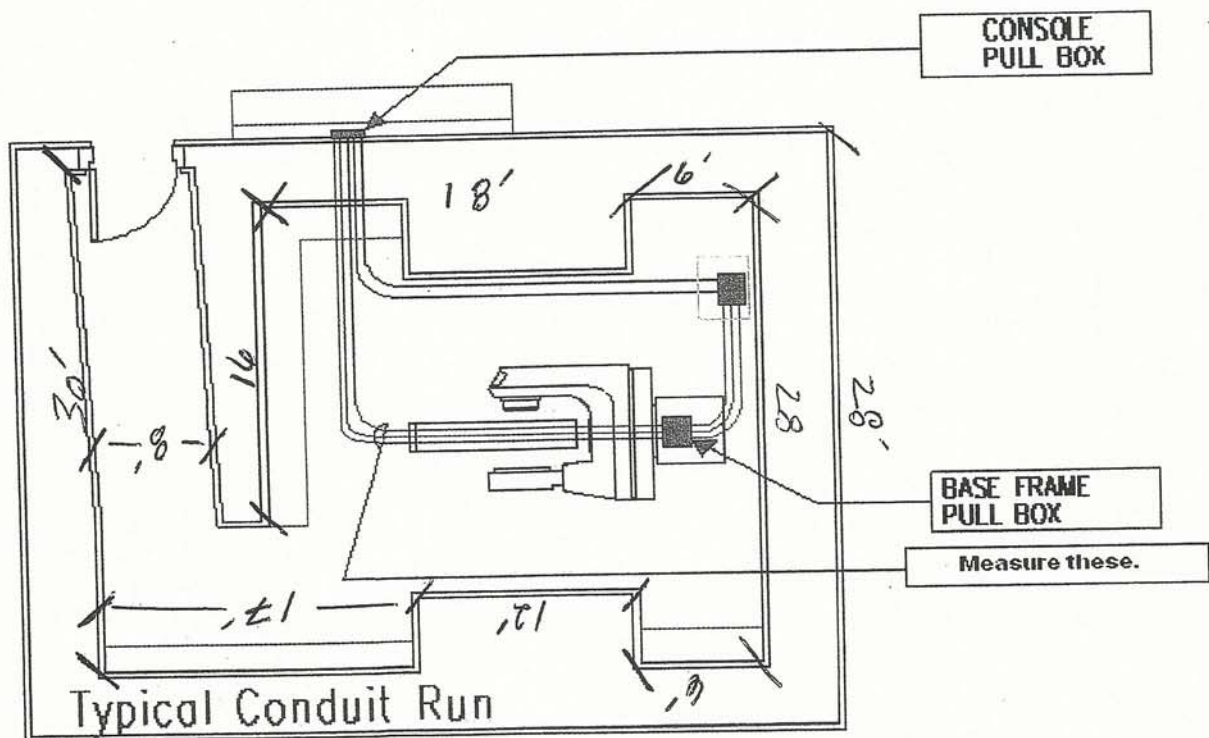

Console pull-box to Baseframe pull-box: _____ feet

Console pull-box to Console Electronics Chassis: _____ feet

Varian Medical Systems 26 S. Front Street, PO Box 215, New Freedom, PA 17349
717-279-1744 (Office) 717-235-2552 (Fax) roy.jackson@varian.com

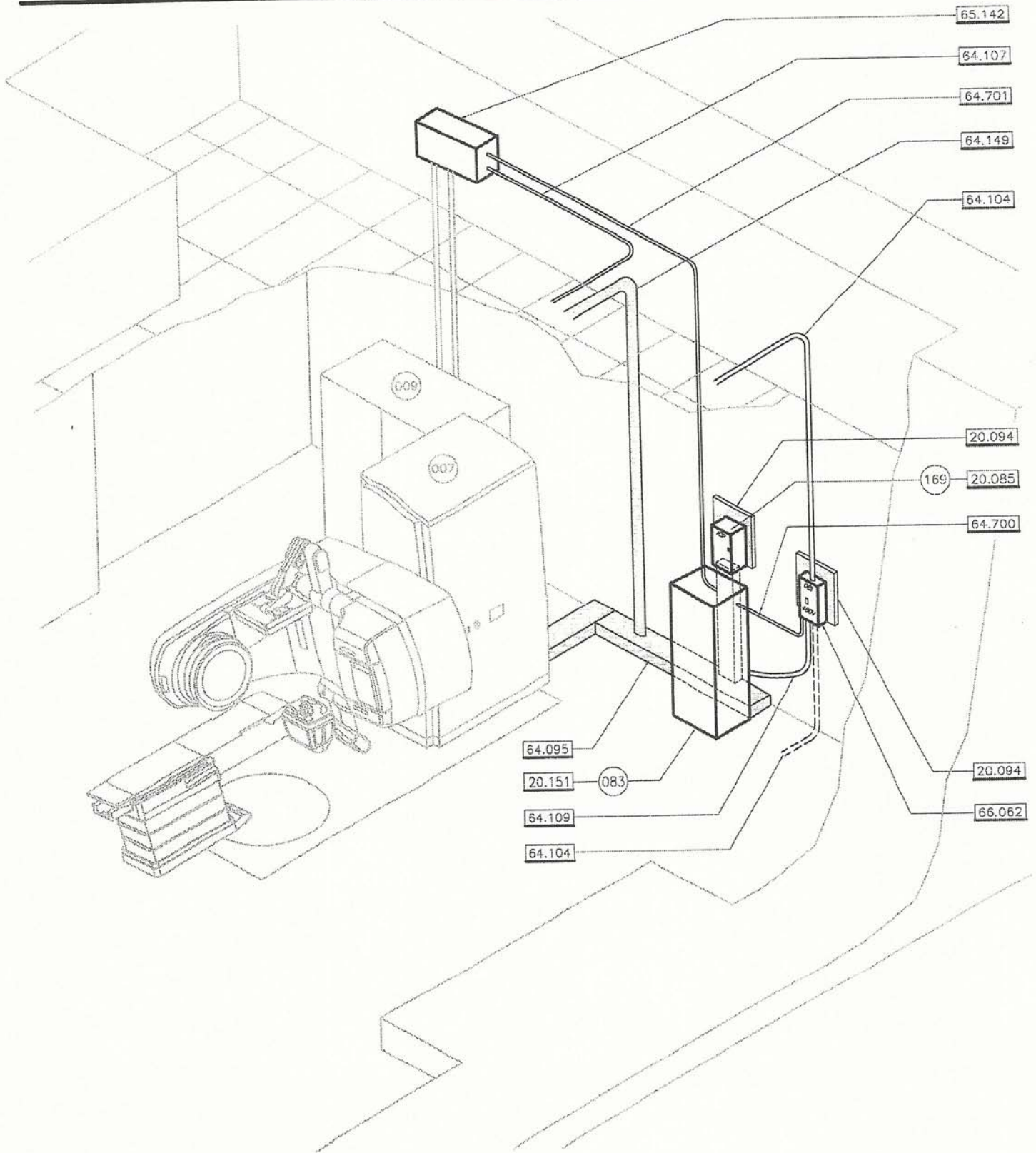

A Typical Room Isometric 10.099 10.124 21.072 53.092

OB1001

	Refer to the Varian Components chart at the end of this section.	On-Board Imager Upgrade Option Room Configuration Clinac 2100C/(D), 2300C/D, 21EX, 23EX		
	Not For Construction			
OC.1.0 :page	planning dept.	© Varian Medical Systems 2004 All rights reserved.	230ct07	revision: 2
		doc. #: 200036	page: OC.1.0	



From: Planning Department

October 08, 2007

Subject: On Board Imager (OBI) Upgrade Memo

The following information should be reviewed with the Customer planning to upgrade their existing Clinac or Silhouette Edition Clinac with an On Board Imager (OBI).

Do not proceed to download an Installation Data Package until the serial number of the Varian Clinac, has been confirmed with the Customer.

Clinac models 2100, 21EX, 2300, and 23EX with the following serial numbers and **BELOW** will receive **dedicated** hardware only:

2100 & 21EX - Serial #2799 and below

2300 & 23EX - Serial #499 and below

Download the "**Dedicated Hardware - Clinac On Board Imager (OBI) upgrade**" from this web page.

Clinac models 2100, 21EX, 2300, 23EX with the following serial numbers and **ABOVE** will receive **integrated** hardware only:

2100 & 21EX - Serial #2800 and above

2300 & 23EX - Serial # 500 and above

All Silhouette Edition Clinacs

All iX Models and Trilogy Clinacs

Download the "**Integrated Hardware – Clinac and Silhouette - On Board Imager (OBI) upgrade**" from this web page.

For assistance or questions, contact your Varian Planning Representative from varian.com-support-architectural-planning, Architectural Support Contact, or the main Varian Planning office.

Varian Medical Systems
Planning Department
911 Hansen Way, M/S C-165
Palo Alto, CA 94304-1028
Phone (800) 278-2747 or (650) 424-5945 • Fax (650) 424-6252
Email: planning@varian.com

Varian Medical Systems • Planning Department
911 Hansen Way, M/S C-165 Palo Alto, CA 94304-1028
Phone (800) 278-2747 or (650) 424-5945 • Fax (650) 424-6252
G:\planning\projects\upgrade\OBI upgrade memo rev 1.doc

Printed or Digital (pdf) Installation Data Package

This is not the complete Installation Data Package (IDP). This section describes only information on specific equipment facility requirements for **On-Board Imager (OBI) Upgrade option**.

- Clinac 2100C/D, 21EX Serial Number to 2799
- Clinac 2300C/D, 23EX Serial Number to 499

Refer to Section One Installation Data Package for complete system requirements
Section 1 Clinac 2100C/D, 21EX, 2300C/D, 23EX, Trilogy Equipment Information and General Information

To obtain a printed copy of any of the Varian IDP's, contact the Varian Planning Department at the address below.

Planning Requirements for New Clinac Treatment Rooms

ξ All requirements for a standard Clinac 2100C/D, 21EX, 2300C/D 23EX installation must be met to install the On-Board Imager (OBI) Upgrade option. Refer to Installation Data Package: Section One - Clinac 2100C/D, 21EX, 2300C/D, 23EX.

ξ All facility requirements for the installation of the On-Board Imager (OBI) Upgrade option will be in addition to the standard Clinac installation requirements.

Planning Requirements for Upgrading Clinac Treatment Rooms

ξ Verification of existing facility requirements for a standard Clinac 2100C/D, 21EX, 2300C/D, 23EX, to install the On- Board Imager (OBI) Upgrade option will be reviewed by Varian and the Customer.

ξ All facility requirements for the installation of the On-Board Imager (OBI) Upgrade option will be in addition to the standard Clinac installation requirements.

Limitation of Liability

Every effort has been made to keep these files consistent with the documents in the IDP. These disks and files are provided "as is" without warranty of any kind, either express or implied. The Architects and Engineers of Record to reflect any and all site-specific conditions and regional regulatory agency requirements shall modify these files. Varian shall not be liable for the accuracy or completeness of the files on these disks, any documents that include portions of them or any damages, direct, indirect, incidental or consequential, including damages for any lost profits or project delays that result from the use of the files included herein.

Contact the Varian Planning Department if you have questions.

Varian Medical Systems
Planning Department
911 Hansen Way, Bldg. 3 M/S C-165
Palo Alto, CA 94304-1028
(800) 278-2747
(650) 424-5945
(650) 424-6252 Fax

E-mail - planning@varian.com

Clinac On-Board Imager (OBI) Upgrade Option Notes

Information and Support

This is not the complete Installation Data Package (IDP). This section describes only information on specific equipment facility requirements for **On-Board Imager (OBI) Upgrade option** for Clinac 2100C/D, 21EX, 2300C/D, 23EX medical linear accelerators. Refer to Section One Installation Data Package for complete system requirements. For more information, contact your nearest regional support office (<http://www.varian.com/support>) or Varian's main Planning Department at:

Varian Oncology Systems Marketing
Planning Department
911 Hansen Way, Bldg. 3 M/S C-165
Palo Alto, CA 94304-1028
(800) 278-2747
(650) 424-5945
(650) 424-6252 Fax
<http://www.varian.com/support>

Equipment Information

The **On-Board Imager (OBI)** x-ray system is an optional accessory to the Clinac high-energy accelerator used for patient positioning and provides high-resolution digital images for target localization.

The x-ray system incorporates Varian's kV x-ray source and amorphous silicon flat-panel digital image detector, and is attached directly to the Clinac on a pair of robotic arms that move relative to each other.

The On-Board Imager system includes an Interconnect Panel (ICP) and High Frequency Generator cabinet to be located within the treatment room. Additional Hardware at the Clinac console is the On-Board Imager workstation and the 4D Console workstation.

Equipment Options

To simplify the design process, we suggest that the Architect and Customer determine, as early as possible, all optional equipment configurations ordered or planned for the future.

Clinac 2100C/D, 21EX

Serial Number to 2799yes/no)

Clinac 2300C/D, 23EX

Serial Number to 499(yes/no)

New Construction

- All requirements for a standard Clinac installation must be met to install the On-Board Imager (OBI) Upgrade option. Refer to Installation Data Package: Section One - Clinac 2100C/D, 21EX, 2300C/D, 23EX.
- All facility requirements for the installation of the On-Board Imager (OBI) Upgrade option will be in addition to the standard Clinac installation requirements.

Upgrade of an existing Facility

- Verification of existing facility requirements for a standard Clinac 2100C/D, 21EX, 2300C/D, 23EX to install the On-Board Imager (OBI) Upgrade option will be reviewed by Varian and the Customer.
- All facility requirements for the installation of the On-Board Imager (OBI) Upgrade option will be in addition to the standard Clinac installation requirements.

OBI Upgrade Requirements:

Architectural:

- Control console changes vary depending on the final Sales Order and existing configuration. If all the Varian options are purchased including a companion Varis Work Station there should be 6 quad outlets and 6 data drops. The control console should be a recommended minimum of 16'-0" linear ft. in length

Structural:

- The existing base frame can be re-used for an OBI upgrade. However, Varian recommends the use of a 52" base frame. If, the existing frame is a 36" frame then, the Customer and the Varian Sales Mgr. should discuss the clinical implications of not replacing the frame.

Mechanical:

- The following heat loads are during Beam-On states. The OBI Option generates 4,265 btu/hr(1.24kW) additional heat load in the treatment room. (The existing "C" or "EX" series Clinac generates 17,060 btu/hr (5.0kW). The Modulator generates 10,237 btu/hr(3.0kW)) Consult a licensed Mechanical Engineer and review the capacity of the existing HVAC system.
- Control console workstations additional heatload 2,560 btu/hr(.75kW)

Electrical:

- The OBI is a KV imager and requires 480V, 60amp, 4 wire, 3-phase and ground and 60kva supply capacity.
- The Main Circuit Breaker (MCB) for the OBI can be located in the room adjacent to the HF Cabinet or adjacent to the 208V (MCB) at the Control Console area.
- Provide a 2" conduit for the new 480V power line and terminate at the OBI Main Circuit Breaker panel. Provide flexible conduit from the MCB panel to the HF Generator Cabinet.
- Provide cable ducting (3 1/2" x 10" with a single divider) from the HF Cabinet to the Clinac Stand, not to exceed 16'-0" in length. This cable duct may be recessed in the slab, surface mounted or wall mounted based on customer preference. An additional run of wall mounted cable duct (3 1/2" x 10" with a single divider) from the ICP panel to the floor tray is required.

Clinac On-Board Imager (OBI) Upgrade Option Notes

OBI Upgrade Requirements: continued

Electrical: continued

- Providing an additional 4" conduit from the control console to the Clinac stand is recommended. Verify this requirement with Varian project management.

- Connections for two warning lights, usually red colored, incandescent (no fluorescent lighting) are provided. Locate over the door, on the outside of the treatment room. They may be required to blink when the x-ray is on. Verify local requirements with regional regulatory agencies.

"X-RAY ON" - warning light (maximum 24vdc @250ma)

"GENERATOR ON" - warning light (maximum 24vdc @250ma) The 24vdc @250ma signal can be used to control a Potter - Brumfield PRD11DG0-24, 24 Vdc (or equivalent) relay to switch higher voltage warning lights. The additional relay(s) can be installed into the existing relay junction box.

Shielding:

- Due to periodic changes in the shielding regulations and higher dose rates associated with this machine, all sites must have the shielding reviewed by the "Physicist of Record".

OBI Components

Key	Equipment	Height inch (mm)	Width inch (mm)	Depth inch (mm)	Weight lb (kg)	Max Watts	Max dBa
022	Workstation Computer	19 (483)	8 (203)	17 (432)	27 (12)	240	n/a
023	Workstation Monitor	20 (508)	22 (559)	4 (102)	18 (8)	n/a	25
080	Control Foot Switch	5 (127)	6 (152)	6 (152)	6.1 (3)	n/a	n/a
083	OBI HF Generator	50 (1270)	18 (457)	16 (406)	250 (113)	n/a	n/a
088	PaxScan Image Command Processor	5.5 (140)	11 (279)	12.5 (318)	16 (7)	n/a	n/a
169	OBI ICP	24 (610)	16 (406)	9 (229)	40 (18)	n/a	n/a
170	4D-Integrated Treatment Console	2 (51)	11.8 (300)	13.7 (348)	5 (2)	n/a	n/a

OBI005

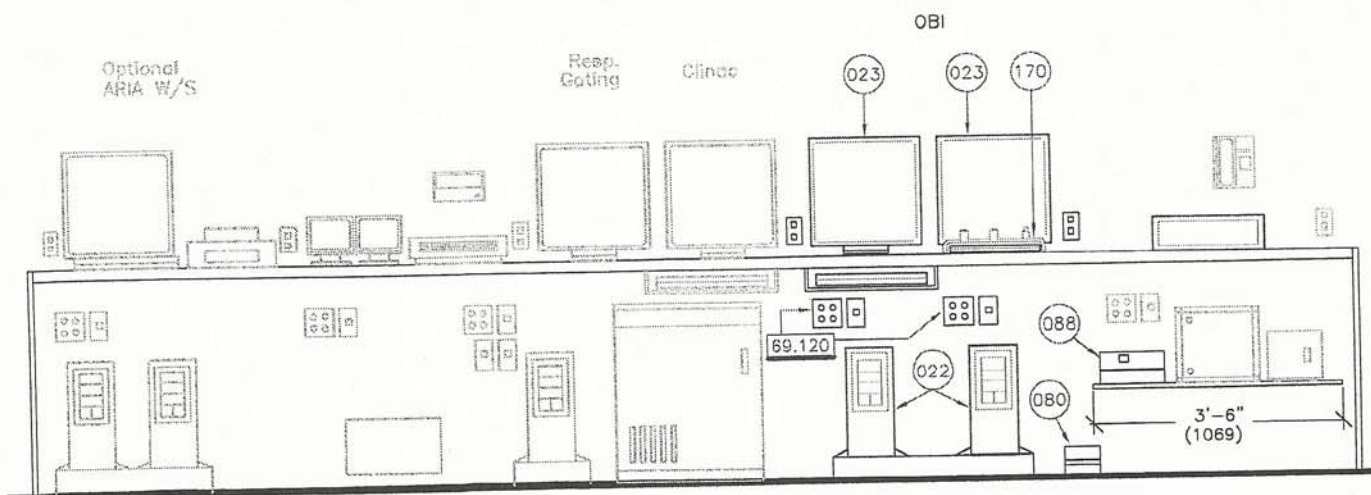
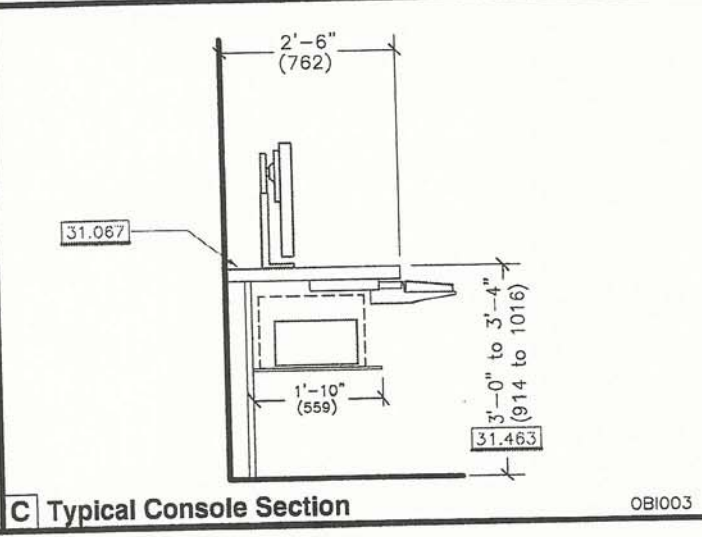
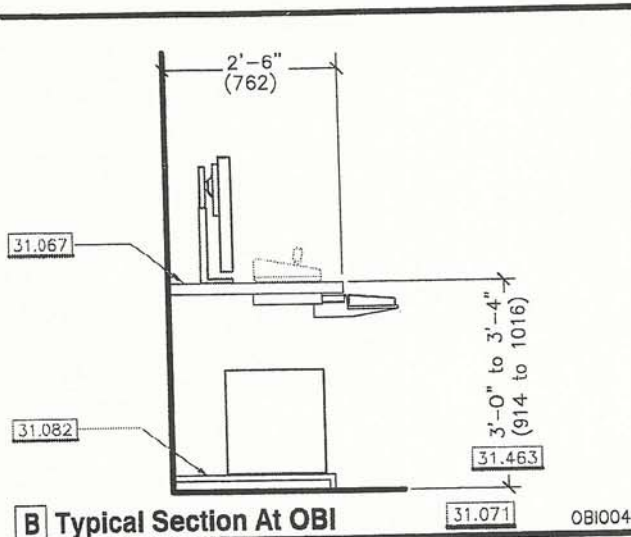

A Typical Control Console Equipment		10.099	21.073	30.024	31.084	53.092	OBI002
scale at: 3/8" = 1'-0"				000 Refer to the Varian Components chart at the end of this section.		On-Board Imager Upgrade Option Console Casework Clinac 2100C/D, 2300C/D, 21EX, 23EX	
OC.2.0 :page		Not For Construction © Varian Medical Systems 2004 All rights reserved.		230ct07	revision: 1	doc. #: 200037	page: OC.2.0

Series 700 AV/T Power Conditioner

Designed for the Varian On Board Imager™

Input Voltages: 208VAC, 240VAC, 480VAC or 600 VAC (60 Hz)

Output Voltage: 480/277 VAC

- Input Circuit Breaker
- Intelligent Voltage Regulation ($\pm 2.0\%$ Output)
- Internal Bypass Switch
- Triple Shielded Isolation Transformer
- Internal TVSS

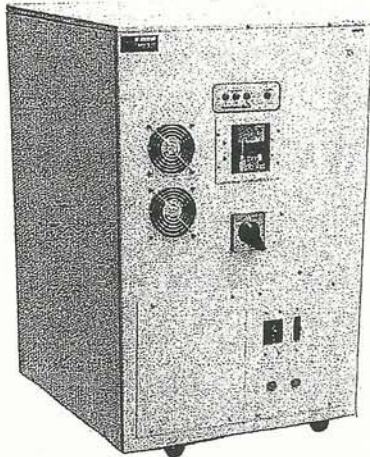

60 kVA(I) Power Conditioner
with Voltage Regulation

Submittal Package and Specifications

 **TRANSECTOR**

TRANSTECTOR SERIES 700 AV/T

Specifications for Varian (OBI) On Board Imaging Imager™ 60 K(I) Power Line Conditioner

1.0 SCOPE

This specification covers the electrical characteristics of the 60 K(I) Power Conditioner which provides clean regulated power for Varian On Board Imager™.

2.0 GENERAL

The Power Line Conditioner consists of an all copper, multiple tapped, triple shield isolation transformer. The low output impedance of the transformer in conjunction with the electrostatic shields assures precision hospital grade performance with excellent noise and transient attenuation. Independently controlled inverse parallel electronic switches for each of the 7 taps per phase provide tight regulation over a wide input range. Linear devices are used for line synchronization to prevent phase shift errors normally associated with simple CT zero current crossing acquisition. The microprocessor control accurately selects the correct tap to maintain the output no greater than $\pm 2.0\%$ of nominal, correcting for voltage disturbances within one cycle. Digital processing technique provides fast and accurate regulation without output voltage over or undershoot.

2.0.1 MODEL NUMBERS

MODEL INPUT VOLTAGE OUTPUT VOLTAGE

Model	Input Voltage	Output Voltages
8BNX-60K(I)-700AV/T	208 volts nominal input	480/277 volts output
8CNX-60K(I)-700AV/T	240 volts nominal input	480/277 volts output
8DNX-60K(I)-700AV/T	480 volts nominal input	480/277 volts output
8ENX-60K(I)-700AV/T	600 volts nominal input	480/277 volts output

2.1 AGENCIES

2.1.1 STANDARDS

The systems shall be designed in accordance with:

- American National Standards Institute
- Institute of Electrical and Electronic Engineers
- National Electric Code (NEC)
- National Fire Protection Association (NFPA Article 70)
- UL 1449, 1012
- FCC Article 15, Section J, Class A
- ISO 9001

2.1.2 LISTINGS / COMPLIANCE

- The system shall be listed to UL/cUL standards UL1012 or ESA approved
- The system shall comply to: FCC Article 15, Section J, Class A
- ANSI C62.14 (electromagnetic compatibility)

3.0 DYNAMIC ELECTRICAL CHARACTERISTICS

3.1 OPERATING VOLTAGE

The input voltage shall be 208 VAC, 240 VAC, 480 VAC or 600 VAC input, three phase 60 Hz. The output shall be a WYE derived 7 tap regulating system at 480/277VAC, rated for 60 KVA intermittent load and 30 KVA continuous load. The standard transformer design shall be capable of accepting three (3) input voltages, 208 VAC, 240 VAC or 480 VAC. Each unit will be pre-wired at the factory to accommodate the alternative nominal input voltage. The input voltage and input breaker can be changed in the field to accommodate an alternative input voltage.

3.2 LINE VOLTAGE REGULATION

Usable Input Line Voltage +15 %, -23 %.

Output Line Voltage ± 2.0 % typical.

The design of the system shall indicate that with an input voltage of -10 % of nominal, increasing the load to 1000 % shall cause the output voltage to fall no lower than -6 %.

3.3 OUTPUT VOLTAGE

Output voltage shall be 480/277 VAC derived from a WYE configuration.

3.4 OUTPUT CONNECTIONS

An output terminal strip is provided for the 480/277 VAC three phase power.

3.5 INPUT/OUTPUT WIRING

The Allen Bradley 1492-CE 2 terminals allow wire sizes from # 12 to # 1/0 to be connected to the input and output terminals. The ILSCO TA-2/0 terminal allows wire sizes from # 14 to #2/0 to be connected to the ground.

3.6 RESPONSE TIME

Response time is less than 1/2 cycle.

3.7 CORRECTION TIME

The output voltage is corrected within 1 cycle.

3.8 LOAD REGULATION

The output is maintained to within 2 % of nominal or less, from no load to full load.

3.9 IMPEDANCE

Output impedance shall be less than 2 %.

3.10 OPERATING FREQUENCY

60 Hertz ± 3 Hertz

3.11 HARMONIC DISTORTION

Less than 1 % THD added to the output waveform under any dynamic linear loading conditions presented to the line regulator.

3.12 TURN-ON CHARACTERISTICS

When energized the voltage overshoot is 5 % or less of the nominal voltage for less than 1 cycle.

3.13 OVERLOAD RATING

200 % for ten minutes.

1000 % for one cycle.

3.14 NOISE ATTENUATION

Common mode noise attenuation is typically 140 dB or greater.

Transverse mode noise attenuation is 3 dB down at 1000 Hertz, 40 dB down per decade to below 50 dB with a resistive load.

3.15 AUDIBLE NOISE

Not to exceed 55 dB measured @1 meter

3.16 EFFICIENCY

98 % Typical at full load. Excitation losses shall be less than 0.75 % of KVA rating

3.17 HEAT OUTPUT

Nominal 1,545 BTU/hour

Maximum 3,090 BTU/hour

3.18 POWER FACTOR

Input power factor shall be greater than .95 with a resistive load and reflect no triplen harmonics to the utility under non-linear loads.

3.19 LINE to LINE BALANCE

The Power Line Conditioner shall not produce more than a 2 % phase to phase unbalance

3.20 MEAN TIME BEFORE FAILURE

The system shall exhibit a MTBF > 10,000 hours.

3.21 SURGE and SPIKE SUPPRESSION

A Transtector model SPD SP 60 TVSS shall be installed parallel to the secondary output of the power line conditioner to provide all-mode, bi-directional and bi-polar surge protection. The SPD is rated for 120 kA per phase, 60 kA per mode capacity. (L-L, L-N, L-G, N-G) The suppression network system shall conform to UL 1449 ratings when subjected to ANSI/IEEE C62.41-1991 category C3 waveforms. Units shall provide attenuation against EMI/RFI noise up to 50 dB at 1 MHz. The surge suppressor is installed on the load side of the transformer, connected in parallel by a 30 Amp circuit breaker.

4.0 MAIN TRANSFORMER

4.1 BASIC CONSTRUCTION

The transformer windings are of all copper conductor construction with separate primary and secondary isolated windings.

4.2 MAGNETIC

Grain oriented stress relieved silicon transformer steel is utilized to minimize losses and provide maximum efficiency. Flux density will not exceed 14 k gauss.

4.3 INSULATION

Class N (200° C) insulation is utilized throughout.

4.4 SHIELDING

The transformer has multiple (three) copper shields to minimize inner winding capacitance, transient and noise coupling between primary and secondary windings. Inner winding capacitance is limited to .001 pf or less.

4.5 COOLING

The transformer is designed for natural convection cooling. Fans are located on the front of the unit.

4.6 OPERATING TEMPERATURE

The system operating range: 0 to 40 degrees C, 32 to 104 degrees Fahrenheit

4.7 OPERATING HUMIDITY

0-95 % relative humidity non-condensing.

5.0 MAIN INPUT BREAKER

A main input molded case, thermal magnetic circuit breaker, rated at 125 % of the full load input current, is furnished as an integral part of the unit. For example, a 110 Amp breaker will be provided for 208 VAC input, a 100 Amp breaker will be provided for a 240 VAC input and a 60 Amp breaker will be provided for a 480 VAC input.

6.0 BY-PASS SWITCH

A manually operated rotary bypass switch provides bypassing of the regulator portion of the Power Line Conditioner. The regulator can be either on-line or bypassed with one turn of the switch. The transformer and suppression circuitry remains in the circuit when in the bypass mode. The bypass switch is located on the front of the unit.

7.0 MONITORING

7.1 ALERT LIGHT

An indicator light shall annunciate that the output has been disabled by one of the following conditions:

- (1) Transformer over-temperature
- (2) SCR thermal over-temperature

7.2 INDICATING LAMPS

Output ON indicating lamps shall provided for each phase.

8.0 CABINET

8.1 TERMINATION

Termination is front access with input and output connections made of copper stand off bus. The unit is constructed using an isolation transformer and is considered to be a "separately derived system". It should be grounded in accordance with the NFPA 70 article 250.20 "Alternating-Current Circuits and Systems to be Grounded", article 250.20 (D) "Separately Derived Systems" and article 250.30 "Grounding Separately Derived Alternating-Current Systems".

8.2 VENTILATION

Ventilation originates from the bottom of the cabinet and exhausts at the front of the cabinet.

8.3 MOBILITY

The Power Line Conditioner cabinets are equipped with fixed casters located so as not to exceed 600 lbs/sq inch on any one caster.

8.4 ACCESSIBILITY

The cabinet is constructed with lift off side panels for ease of access. The right side is the access panel for the SCR controller boards.

8.5 WEIGHT

Unit weight: 720 lbs (325.2 kg)

8.6 DIMENSIONS

21.5" W X 29" D X 44" H (54.6 cm x 73.6 cm x 111.8 cm)

9.0 CONTROLS

The control portion of the cabinet containing the circuit boards and connection to the semiconductor devices is separate from the transformer and input / output termination.

10.0 WARRANTY

Units shall include a comprehensive warranty for the first year, covering all parts and workmanship, inclusive of on site labor and travel expenses in geographic areas covered. Consult factory for details. All units are provided with a standard two year warranty covering parts and workmanship.

11.0 SERVICE

Transtector shall provide immediate phone support/consultation and if possible, same day parts shipment. (Contact must be prior to 12:00 PM PST). If necessary, on site service shall be scheduled the same day for service to be conducted within 24 to 48 hours, based on customer requirements. Typical service hours are 8 AM to 5 PM Monday through Friday.

12.0 CONTACT

Rick Ribbeck	Phone: (01) 208.762.6112 or 1.800.882.9110 extension 6112
Transtector Systems	Cell: (01) 208.755.2072
10701 Airport Dr.	Fax: (01) 208.762.6133
Hayden Lake ID 83835 USA	Email: rribbeck@transtector.com

SEISMIC CALCULATIONS

Coastal California, Zone 4
 Equipment Anchorage
 Uniform Building Code, Table 160

$Z = 0.4$
 $I = 1.5$
 $C_p = 0.75$

$$F_p = Z \times I \times (C_p) \times W_p = 0.45 \times W_p$$

Cabinet Weight
 Center of Gravity Height

774 lbs.
 19.00 in.
 $W_p(\text{max}) = 890.1 \text{ lbs.}$
 $W_p(\text{min}) = 657.9 \text{ lbs.}$

Vertical Force
 Moment

$F_p = 0.45 \times 890 = 400.5 \text{ lbs.}$
 $(F_p) = 0.15 \times 890 = 133.5 \text{ lbs.}$
 $M_o = 19 \times 400.5 = 7610.4 \text{ in. lbs.}$

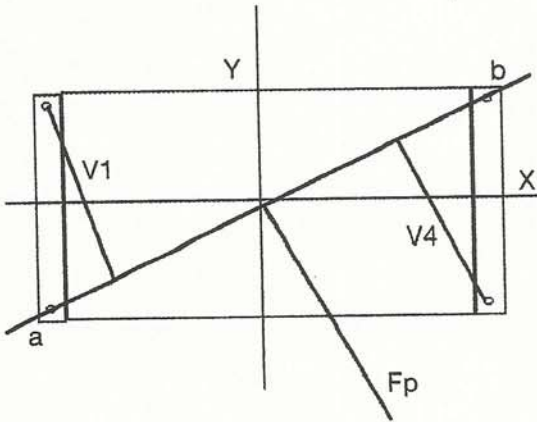

Corners (a,b) 36.0 in.
 $V_1 = V_4 = 16.5 \text{ in.}$
 Tension = $F_p \times C_g / \sqrt{4} = 890.9 \text{ lbs}$
 Shear = $W_p(\text{max})F_p/4 \text{ lbs., each anchor}$
 = 222.5 lbs.

EXAMPLE: <Rawl Power Bolt # 6913>
 3/8" embedded 2.5" in minimum
 2000psi concrete
 Tension Rating of bolt: 5200 lbs.
 Shear Rating of bolt: 7270 lbs.

Interaction = $(T/T_{\text{bolt}}) + (S/S_{\text{bolt}})$
 Interaction = .2
 Interaction = < 1 (OK)

Exhibit B
Replacement Equipment

[See Attached]



Versa HD



ELEKTA

Versa HD™

The convergence

of conventional radiotherapy with

advanced stereotactic precision.

Versa HD is not available for sale or distribution in all markets. Please contact your Elekta representative for details.

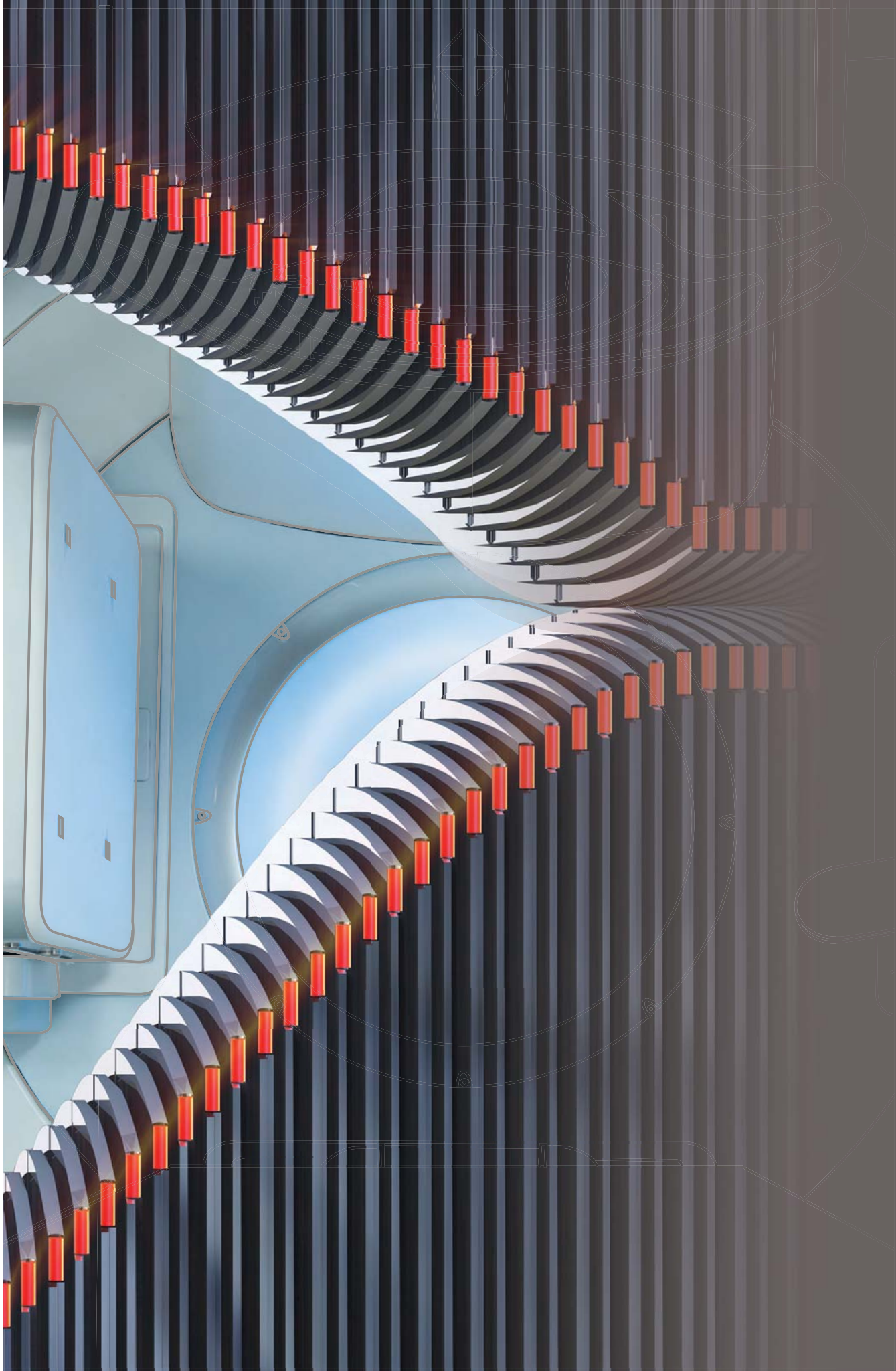

One Solution. Unlimited Possibilities.



Versa **HD**

One Solution. Unlimited Possibilities.



Versa HD™

A single delivery system with **unmatched versatility**

Recognizing the emergence of increasingly advanced therapies combined with unprecedented demands to maximize health care resources, Elekta is pleased to introduce Versa HD™.

Providing the flexibility to safely and efficiently deliver the full spectrum of conventional radiotherapy techniques, Versa HD advances modern cancer care with the added versatility to deliver sophisticated linear accelerator-based stereotactic treatments – all within a single delivery system.

New standards in **treatment efficiency**

Elekta's new and innovative High Dose Rate mode leverages the latest advances in flattening filter-free beam technology and provides maximum dose rates three times higher than previous generation Elekta linear accelerators. With the option to deliver conventional and high dose rates, Versa HD enables highly sophisticated therapies without compromising treatment times.



Versa HD

One Solution. Unlimited Possibilities.

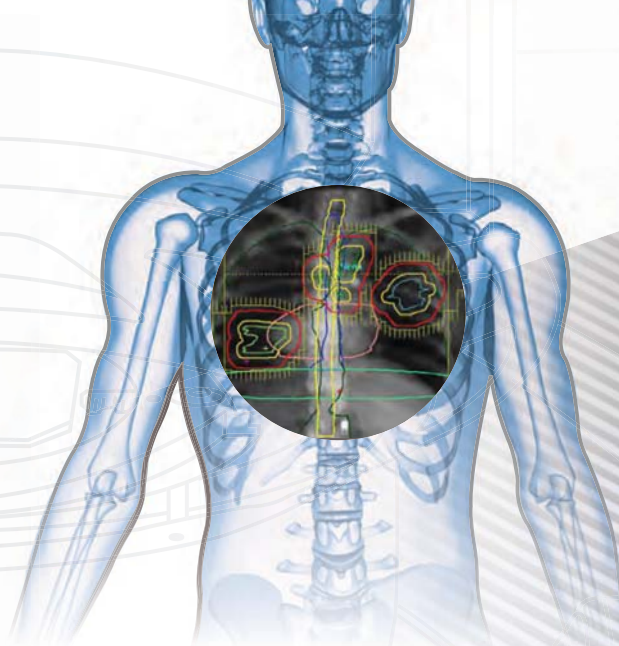

Superior **target conformance**

Versa HD features Agility™, Elekta's revolutionary multi-leaf collimator. Agility utilizes 160 fine-resolution leaves, a 40 cm x 40 cm treatment field and leaf speeds more than two times faster than other MLC systems. The patented Rubicon™ leaf-positioning technology of Agility verifies leaf movement in real time, providing extreme precision, high reliability and enhanced conformance for a broad range of cases.

The full potential of **High Dose Rate delivery**

With Versa HD, the unique combination of ground-breaking MLC leaf speeds with High Dose Rate mode means clinicians can, for the first time, explore the full capabilities of high dose rate delivery and take advanced therapies such as VMAT, SRS and SRT to new levels.

VersaHD™

Precision

Versa HD™

Soft tissue imaging during delivery

With the ability to image during treatment delivery, Versa HD provides an opportunity to reduce treatment time-slots to improve clinical efficiency. Combining imaging and treatment delivery also reduces the likelihood of patient movement and changes in internal organ position during the treatment session. This means that patient care is further enhanced while giving clinicians the flexibility to provide a patient-specific workflow.

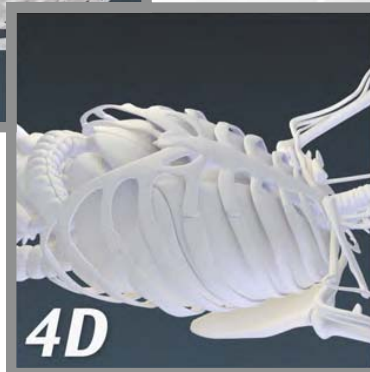
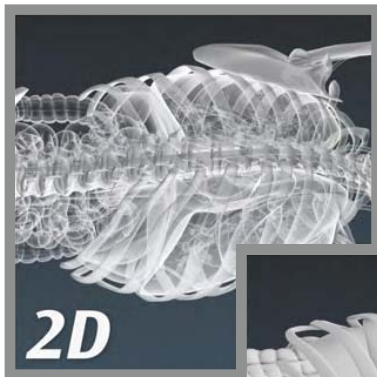



Anatomically correlated **4D imaging**

Unique to Elekta, Versa HD delivers state-of-the-art 4D soft tissue visualization to manage respiratory motion and accurately target mobile lung tumors – a difficult task before the introduction of this advanced technology. 4D image guidance technology allows clear visualization of moving targets to enable margin reduction to set new standards in lung treatment.

Integrated care management for radiation and medical oncology

Versa HD is supported by Elekta's integrated software solutions to deliver immediate access to clinical and patient information. Rapid access to this data enables multi-disciplinary teams to make more informed treatment decisions. MOSAIQ enables clinicians to effortlessly coordinate the patient's entire continuum of oncology care. Through a powerful combination of clinical and patient data available at the user's fingertips, personalized treatments can be created across multiple modalities specific to each patient's disease. Advanced workflow customization and automation supports faster, more effective patient throughput, leading to greater efficiency and a paperless practice.

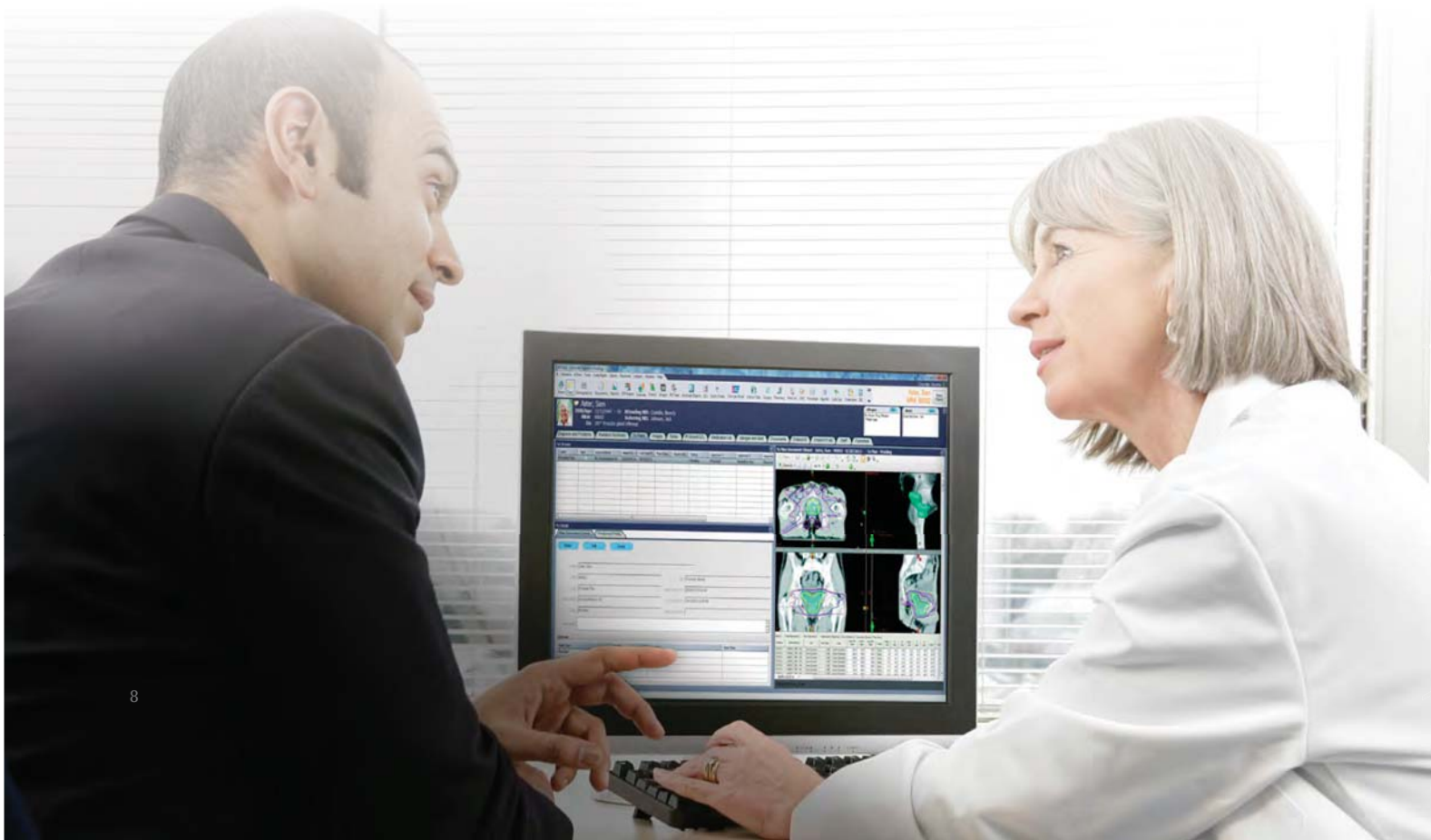

Precision plans for all major treatment techniques

With sophisticated tools to make planning easier, reproducible and clinically reliable, Monaco® redefines treatment precision and conformance, enabling the delivery of the most advanced 3D CRT, IMRT, VMAT and SBRT therapies. Powered by the Monte Carlo algorithm, the most accurate dose calculation currently available, Monaco leads the way in dose conformity, delivery efficiency and sparing of organs-at-risk. Combining these capabilities with modern architecture technology, Monaco sets a new standard in accuracy and speed, reducing planning and treatment times and improving plan quality.

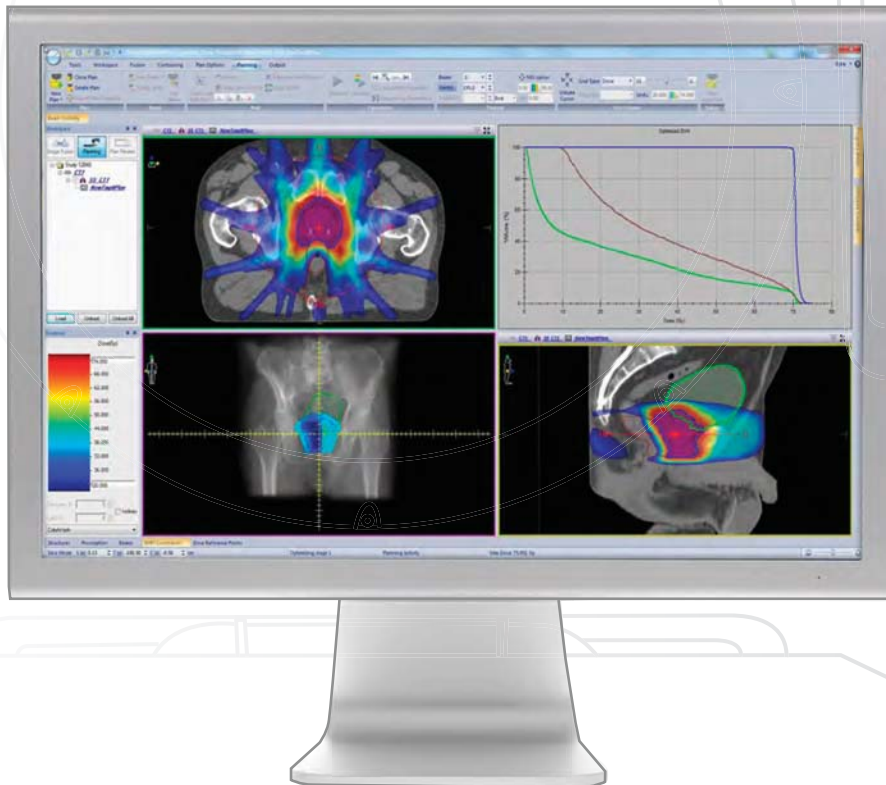

VersaHD™

Custom configurable for unique clinical needs

Versa HD is supported by a series of packages designed to address unique clinical challenges, making it easy to customize a system that meets your specific needs and those of your patients.

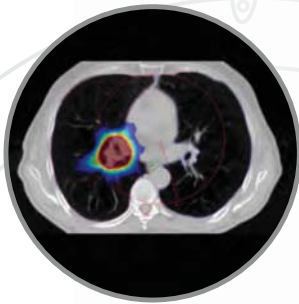

Lung

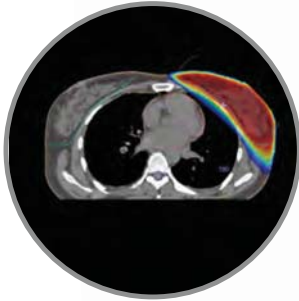

Breast

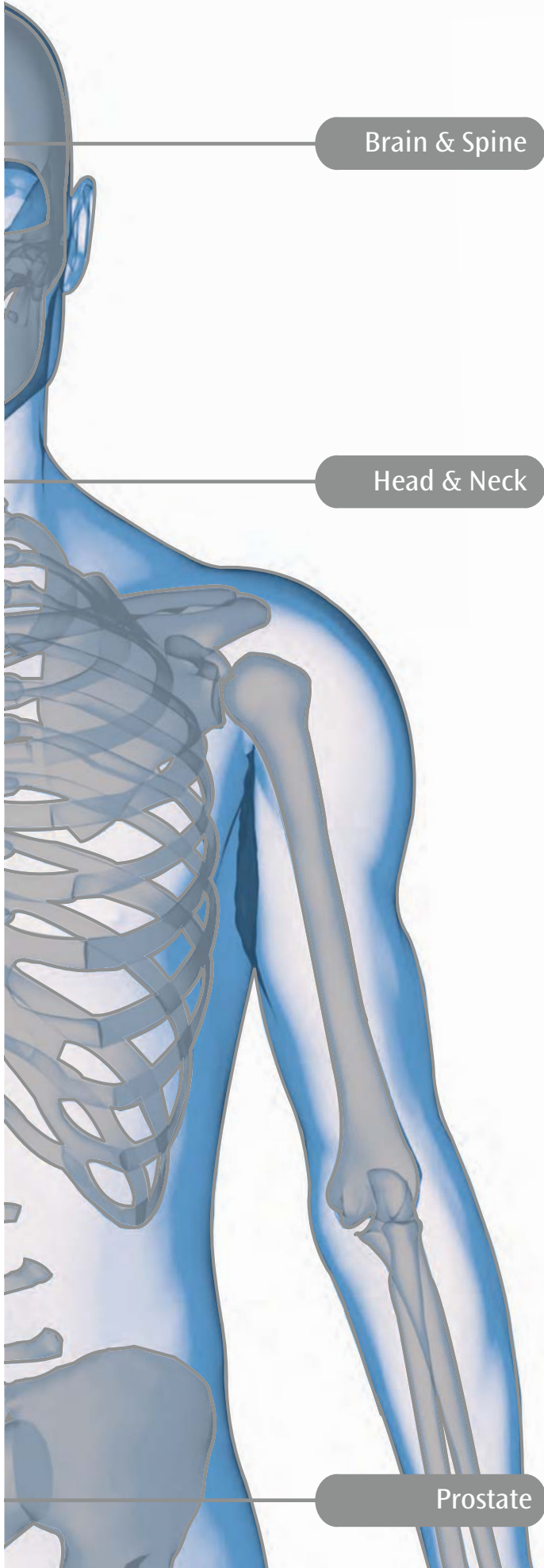

Brain & Spine

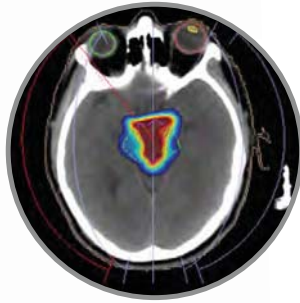

Head & Neck

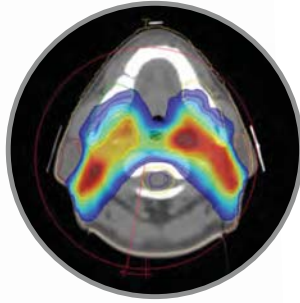

Prostate

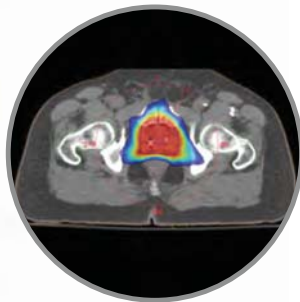



Versa HD™

Safety by design

Versa HD was designed with patient safety in mind:

- ❖ Decrease collision risks with touch-activated patient protection and the market's largest isocenter clearance
- ❖ Reduce non-therapeutic doses with the lowest radiation transmission of any commercially available MLC
- ❖ Visualize broad regions-of-interest with the industry's largest IGRT cone-beam CT field-of-view
- ❖ Audit and safely orchestrate multiple linac functions with Elekta's seventh generation digital control system



Confidence



Versa HD™

Elevated **patient experience**

Versa HD is designed with new ergonomic features and softer streamlined shapes, creating a confident and relaxed treatment environment. Combining low mechanical noise with ambient lighting effects, Versa HD was designed with patient comfort in mind.

Real-time **remote system monitoring**

Elekta Remote Services proactively monitors key system functions in real time and provides notification of potential problems before they occur. With more than 25 years of digital linear accelerator expertise, Elekta provides Versa HD users with fewer delays and reduced downtime.



Versa **HD**

Experience



www.VersaHD.com

www.VersaHD.com

www.elekta.com

Corporate Head Office:

Elekta AB (publ)
Box 7593, SE-103 93 Stockholm, Sweden
Tel +46 8 587 254 00
Fax +46 8 587 255 00

info@elekta.com

Regional Sales, Marketing and Service:

North America

Tel +1 770 300 9725
Fax +1 770 448 6338

info.america@elekta.com

Europe, Middle East, Africa,
Eastern Europe, Latin America
Tel +46 8 587 254 00
Fax +46 8 587 255 00

info.europe@elekta.com

Asia Pacific

Tel +852 2891 2208
Fax +852 2575 7133

info.asia@elekta.com

Human Care Makes the Future Possible



ELEKTA

Exhibit C
Cost Summary

Item		Cost
Land	Existing	N/A
Equipment	Elekta VersaHD Linear Accelerator	\$1,350,000.00
Construction		\$327,000.00
Sales Tax	8%	\$134,400.00
Contingency	7%	\$117,390.00
Professional Fees	Legal	\$30,000.00
Total Project Cost		\$1,958,550.00

Exhibit D

Documentation Supporting Costs

[See Attached]



January 28, 2021

Christopher Radcliffe
Genesis Care of Florida
2270 Colonial Blvd.
Fort Myers, FL 33907

Re: 2802 McLamb Pl. Goldsboro, NC 27534 Linear Accelerator Change Out

We are pleased to present you with this proposal for the above referenced project. Our proposal is predicated upon costs from previous linear accelerator change outs and information received to date.

General Conditions – 1 month	\$38,577.00
Existing Conditions/General Requirements	\$17,160.00
Concrete/Grade Beam Replacement	\$20,000.00
Casework	\$25,000.00
Doors & Hardware	\$ 1,236.00
Framing/Drywall and ACT	\$12,000.00
Flooring	\$ 9,000.00
Painting	\$ 4,000.00
E-Frame, Raceways	\$29,000.00
Plumbing/HVAC	\$65,000.00
Electric	\$60,000.00
Permits and Inspections	\$ 2,200.00
Insurance & Taxes	\$ 4,031.00
Fee	\$29,317.00
Construction Contingency	\$10,000.00

Base Bid Total Construction \$326,521.00

We anticipate the work to be substantially complete in approximately 1 Month. Scope of work is limited to only such work as is required to modify the existing vault to accommodate the new Elekta Equipment. Scope of work does not include any modifications to the Vault's size, shape, structure, or shielding. It is assumed that the Building's Fire Protection, Plumbing, HVAC and Electrical Systems are adequate to meeting requirements of the new equipment and are code compliant. Should you have any questions or comments, please do not hesitate to call.

Sincerely,

Dave Kovalik
Vice President – Div. Mgr. Detroit

**BUILT
ON DD
SAFETY**

deangelisdiamond.com

Naples, FL
6635 Willow Park Drive
Naples, FL 34109
o: 239.594.1994

Fort Myers, FL
8695 College Parkway
Suite 2042
Fort Myers, FL 33919
o: 239.594.1994

Sarasota, FL
260½ Cattlemen Road
Suite 404
Sarasota, FL 34232
o: 941.952.3846

Birmingham, AL
1800 International Park Dr.
Suite 205
Birmingham, AL 35243
o: 205.977.7798

Nashville, TN
2179 Edward Curd Lane
Suite 202
Franklin, Tennessee 37067
o: 615.922.3995

Detroit, MI
39555 Orchard Hill Place
Suite 235
Novi, MI 48375
o: 248.513.6112

the
honor
to
build

The following are assumptions and clarifications that have been made in our proposal based the Architectural Design documents as mentioned in the deliverable. No cost or time has been accounted for in the estimate to address the issue of any items identified as “**excluded**”. Changes to the following will result in a modification to the budget and may require revisions to the project schedule.

GENERAL CLARIFICATIONS

1. Note: We have included a construction contingency of \$10,000 in our number.
2. We have included the E-frame, Elekta Raceway, Brain Lab raceway/floor boxes per Finn Industries quote based on assumption from previous jobs.
3. Work to be performed on straight time during standard hours of operation.

INSURANCE

1. General Liability Insurance is included at a rate of 1.25% of the total project volume. General Liability Insurance will be billed in its entirety at the beginning of the project.

DIVISION 00 AND 01 GENERAL CONDITIONS

1. Costs required to construct the project, including:
 - a. Onsite Supervision
 - b. Toilet facilities at job office
 - c. Daily clean up
 - d. Dust barriers
 - e. Safety
 - f. Reproduction costs for bid and construction documents
 - g. Dumpsters (2) and clean up
 - h. Final Cleaning

DIVISION 02 DEMOLITION/CONCRETE

1. Remove and dispose of the following: partitions, doors, millwork, flooring, acoustical ceiling/grid, ductwork, plumbing fixtures and piping, flooring adhesive, interior concrete slabs. Slabs assumed to be 12” thick.
2. We have included an allowance for concrete pour back.

DIVISION 03 MILLWORK

1. Furnish and install plastic laminate base and upper cabinets with solid surface countertops in the following areas:
 - a. Control room cabinets and counter tops
 - b. Treatment room cabinets and countertop

DIVISION 08/09 DOORS/HARDWARE, FINISHES

1. We have included any fire caulking of penetrations through walls, but have not included any fire spray of structural components of building.
2. (2) welded hollow metal frames, (2) wood doors to match existing, (2) passage hardware sets

- a. NOTE: Lead time on wood doors is approximately (8-10) weeks
3. Apply (1) coat of drywall primer to all new drywall, apply (2) coats of eggshell finish coat to all new drywall, apply (1) coat of flat finish to gypsum ceilings to receive paint.
 - a. We have not included any wall coverings.
4. Metal stud interior walls to be 20 gauge. Gypsum board finish to level 4.
5. Unfaced fiberglass insulation in interior walls
6. Acoustical ceilings and grid included per Genesis Care standard.

DIVISION 22/23/26 – PLUMBING, HVAC, ELECTRICAL

1. Plumbing:
 - a. Wall mounted accessible sink with accessories.
2. HVAC:
 - a. Furnish and install new Drake Chiller
 - b. Existing ACCU to remain.
 - c. Start up, testing and balancing included
3. Electrical:
 - a. Allowance based on previous experience and costs with projects

EXCLUDED ITEMS

To further clarify the scope above, the following items are **excluded** and/or are by Owner. This is not intended to be a complete listing of Owner costs.

1. Unforeseen conditions
2. Permit/Inspection fees
3. Design/Architectural fees – separate contract - DB
4. 3rd party inspections/equivalent to CON requirements
5. Testing
6. Arc Flash coordination and study
7. Fire Alarm – reuse existing. Assumed no new devices are required.
8. Fire Sprinkler work
9. Asbestos survey/abatement
10. Wall coverings
11. Computer cabling and equipment
12. Phone/data cabling and equipment
13. Security/Access controls
14. Building Management System
15. Radiation Shielding – by owner
16. Brain Lab Equipment – by owner
17. Floor boxes by others



Quotation number: 2021-313872-RA

Quotation Date: February 03, 2021

Date: February 04, 2021

Quotation

Prepared for:

GenesisCare USA - Goldsboro, NC
ACCOUNTS PAYABLE 2802 Mclamb PI
Goldsboro, North Carolina 27534-1600
United States

Prepared by:

Robby Adams
Healthcare Sales Director - Linac
400 Perimeter Center Terrace, Suite 50
Atlanta GA 30346
(t) +1 770 670 2503
(c) 404-513-3260
robby.adams@elekta.com

Elekta is pleased to submit the following Quotation for the products, software licenses, and/or services as described herein at the prices and terms stated.

The estimated pricing set out in this Quote shall expire September 03, 2021

Hardware and/or Software Price

Description	Currency	Price
Total List price (*)	USD	\$7,155,228.79
Total Discount (*)	USD	\$5,805,228.80
Total Price (*)	USD	\$1,350,000.00

* Excluding Taxes

For U.S. customers, this purchase is subject to the discount provisions of the federal anti-kickback statute, 42 U.S.C. § 1320a-7b(b), and the discount safe harbor regulations at 42 C.F.R. § 1001.952(h). In accordance with such provisions, Customer shall fully and accurately report all prices paid net of discounts where appropriate, and as appropriate, in the costs claimed or charges made under any Federal or State healthcare program, and provide information upon request to Medicare, Medicaid and other applicable federal and state health care programs on all discounts and price reductions received from Supplier.

Price Payment Schedule

Unless otherwise agreed, all fees shall be due and payable in full upon final signature of an agreement. State, local, VAT and other taxes, and import/export licenses are not included in this Quotation.

Software

Unless otherwise agreed, the license fee for the Software embedded in the Hardware is included in the Price set forth above.

Delivery Date

Delivery date for the Deliverables is estimated to be within 120 days from date of agreement subject to payment of fees due. Delivery term shall be CIP Site as defined in Incoterms 2010.

Pricing confidentiality

This Quote and the pricing terms set out herein are negotiated between the Customer and Supplier and may be unique to the Customer. Therefore, and except as otherwise provided by law, Customer hereby agrees to keep the pricing arrangement confidential for a period of no less than three (3) years from the date signed quote. Customer will not use this Confidential Information in furtherance of its business, or the business of anyone else, whether or not in competition with the Supplier.

Purchase Order: _____

EXHIBIT A

Scope of Supply for Hardware and/or Software

Qty	Description
1	<p>Elekta Versa HD™ Versa HD™ provides:</p> <ul style="list-style-type: none"> • Digital accelerator with exclusive cover set design; • Agility™, Elekta's integrated multi-leaf collimator that provides full field high resolution beam shaping (5mm at isocentre), a 40 x 40cm treatment field and effective leaf tip speed of up to 6.5cm/sec, capable of covering multiple targets with interdigitation and island shapes; • 6MV and 10MV flattened energies delivered as standard; • A broad spectrum of delivery techniques from 3D Conformal Radiotherapy to IMRT, VMAT and SRT techniques; • XVI, offering 2D and 3D kV image guidance for advanced soft tissue visualization supporting image guided treatment workflows, XVI Software options VolumeView™, MotionView™ and PlanarView™ are included; • iViewGT™, offering 2D MV imaging capability supporting image guided treatment workflows. • IntelliMax™ Intelligent Agent license is included. Any provision of services relating to the use of data collected by the Agent (via the IntelliMax Enterprise) should be negotiated as part of the Service Contract between the Customer and the BU/distributor. IntelliMax Intelligent Agent requires a dedicated PC. Provision of this PC must be negotiated between the Customer and the Elekta BU/Distributor. A specification of the PC can be obtained from your Elekta representative. IntelliMax Intelligent Agent also requires a direct internet connection to the Agent PC opening secure port 443 (https).
1	<p>Stereotactic MV Isocenter Setup Service to evaluate the MV (Gantry), and combined MV (Gantry) and table isocenter using software tool based on the Winston Lutz test. The following values will be achieved at 6 MV;</p> <ul style="list-style-type: none"> • MV isocenter (Gantry): ≤ 0.7 mm radius • Combined MV isocenter (Gantry) and table isocenter: ≤ 1.1mm radius.
1	<p>Goalpost Assembly Elekta Synergy® Platform, Elekta Synergy®, Elekta Infinity™, Elekta Axesse™ and Versa HD™ compatible standard goalposts.</p>
1	<p>Versa HD standard cover set.</p>
1	<p>High Dose Rate Mode Hardware Upgrade Kit</p>
1	<p>6MV High Dose Rate Software License High Dose Rate Mode provides flattening filter free beam delivery of 6MV beams at dose rates up to 1,400 MU/min, as well as reduction in scatter, lowering whole body radiation doses.</p>
1	<p>10MV High Dose Rate Software License High Dose Rate Mode provides flattening filter free beam delivery of 10MV beams at dose rates up to 2,200 MU/min, as well as reduction in scatter, lowering whole body radiation doses.</p>
1	<p>6 MeV Electron Energy</p>
1	<p>9 MeV Electron Energy</p>
1	<p>12 MeV Electron Energy</p>
1	<p>15 MeV Electron Energy</p>
1	<p>U.S.A. Electron Flatness Electron flatness according to U.S.A. standards, optimized at 100 cm.</p>
1	<p>Aperture Plate Electron Beam Applicator 25 x 25 cm Fitted with spring loaded touch guard, coded end frames and electrical connection to linear accelerator. The X-ray diaphragms are then set automatically to the optimum position. A unique hook and latch mounting system enables easy and rapid attachment.</p>

Qty	Description
1	<p>Standard Set of Aperture Plate Electron Beam Applicators Field sizes:</p> <ul style="list-style-type: none"> • 6 x 6 cm, SSD 95 cm • 10 x 10 cm, SSD 95 cm • 14 x 14 cm, SSD 95 cm • 20 x 20 cm, SSD 95 cm <p>Fitted with spring loaded touch guard, coded end frames and electrical connection to linear accelerator latch mounting system enables easy and rapid attachment.</p>
1	<p>VMAT CAT (Volumetric Arc Therapy Customer Acceptance Test)</p>
1	<p>Response™ Gating Control System for Digital Accelerators Response provides a seamless interface that supports automated gated treatment delivery for a range of delivery techniques on the Elekta Digital Accelerator. The gating signal can be provided by a validated external motion management system, such as the Active Breathing Coordinator™.</p>
1	<p>SYNERGISTIQ™ Software License Enables the XVI functionality to support SYNERGISTIQ. SYNERGISTIQ integrates MOSAIQ® and XVI into a consolidated and synchronized user interface.</p>
1	<p>Software Media Pack, SYNERGISTIQ™ Clients</p>
1	<p>SYNERGISTIQ™ Monitor kit Specification for Extender/Receiver and cable for a remote monitor. Required for sites that use SYNERGISTIQ with a remote monitor in the treatment room.</p>
1	<p>kiloVoltage Cone-beam CT Hardware for Versa HD™</p>
1	<p>40kW kV generator - 480V The integrated 40kW kV generator provides multiple settings control via the XVI software. Acquisition parameters are configured within the preset protocol function in the XVI software, and is user configurable. The generator and X-ray tube have been optimized for the 3D VolumeView™ imaging, as well as the 2D radiographic type exposures of PlanarView™ and MotionView™.</p>
1	<p>Intrafraction Imaging License Provides the ability to acquire kV images during the delivery of an MV treatment field. Intra-fraction imaging allows you to:</p> <ul style="list-style-type: none"> • Acquire images (2D fluoro) for a specified time, and then move directly into a 3D volumetric acquisition. • Acquire a 3D volumetric image during conformal, IMRT or VMAT MV deliveries to measure intrafraction movement. • Perform Intra-fraction 3D or 4D volumetric imaging and registration per arc during dual (or multiple) arc procedures, allowing table corrections in between arcs.
1	<p>Symmetry™ License Symmetry is primarily indicated for respiratory motion management. It offers a unique 4D IGRT online solution that is correlated to internal organ movement. It facilitates for the planned dose to be delivered to the volume where the target spends most of its time in. This allows for margin reduction and baseline shift compensation, supporting treatment deliveries during free-breathing with no surrogates. The use of Symmetry does not require planning on a 4D reference CT.</p>
1	<p>Critical Structure Avoidance Critical Structure Avoidance allows the registration of two separate areas of anatomy, utilizing both the clipboard and the Shaped Registration Region of Interest. XVI software will calculate the relationship of both areas of anatomy to the proposed correction vectors and alert the user if the target has moved closer to the critical structures due to anatomical changes. The user can then choose to select a compromise between the two areas, or send the patient for re-planning.</p>
1	<p>3D Automated Seed Match License Offers an optimized 3D registration algorithm to register implanted markers, without compromising on 3D volumetric information.</p>
1	<p>Hounsfield Units Hounsfield Unit (HU) Scaling uses calibration measurements to calculate the HU mean accuracy to ±40 HU for the small field of view for specified imaging conditions. HU Scaling changes the pixel values for the 3D VolumeView images. HU calibration provides greater soft tissue detail, ensuring a more accurate picture of where dose is being delivered, aiding in critical structure avoidance.</p>

Qty	Description
1	<p>Distributed Review Distributed Review allows the sending of XVI CBCT data to MOSAIQ® for review at any MOSAIQ® workstation, as well as the primary XVI workstation. Pre-requisites:</p> <ul style="list-style-type: none"> • Distributed Imaging/Treatment • DICOM CT Export (+/- Auto DICOM CT Export).
1	<p>Distributed Imaging Distributed Imaging allows the transfer a patient between XVI systems without having to prepare the registration settings on the secondary XVI system, through MOSAIQ®.</p>
1	<p>Elekta XVI Basic Calibration Kit - Bearing Phantom Assembly Specially designed geometric calibration phantom for kV to MV isocentre alignment. Suitable for the XVI system with the iBEAM® evo couch top.</p>
1	MRT 9931 ADAPTOR KIT. PHANTOM
1	<p>XVI Daily QA Phantom Kit Daily QA Phantom for kV and MV projection imaging and kV VolumeView™. Checks the laser and light field coincide and additionally provides a spreadsheet for recording and analyzing trend results.</p>
1	<p>XVI Water Calibration Kit Water phantom calibration kit for XVI calibration. It provides a reduction in CBCT image ring artefacts in addition to image quality improvements.</p>
1	<p>VolumeView™ Contrast phantom QA phantom to enable measurement of high resolution and contrast resolution and other image quality parameters of the VolumeView images acquired on the XVI workstation.</p>
1	2D TEST OBJECT, MRT 10321
1	<p>DICOM 4D export 4D DICOM export allows the user to export to a third party system the CBCT data as generated by Symmetry™ of:</p> <ul style="list-style-type: none"> • Average phases • All phases • Single phase.
1	<p>Archive and retrieve to network Performs automatic archiving of patient images to a pre-defined network location, outside of MOSAIQ®. Archiving can be scheduled, and the network location can be specified at will. The same tool performs retrieval of files from the same location.</p>
1	<p>Versa HD™ iViewGT™ This kit contains all of the components for iViewGT including;</p> <ul style="list-style-type: none"> • A MK 6 imaging control system cabinet with the iViewGT software R3.4.1. pre-installed. • A rigid and fully retractable slim line MV imaging detector arm with a large, square active detector area and wide lateral and longitudinal movement adjustments. The arm has automatic and manual arm movements and is fully interlocked.
1	iViewGT™ R3.4.1 Installation Kit
1	iViewGT™ R3.4.1 Software License
1	<p>iViewGT™ R3.4.1 Software License Collation Third Party License toolkit necessary for supporting iViewGT.</p>
1	<p>Remote Retraction of the iViewGT™ detector - 30M This kit allows Remote Retraction of the iViewGT detector from the Function Key Pad.</p>

Qty	Description
1	<p>DICOM 3.0 software interface for image transfer The international standard interface protocol for network transfer of medical images.</p>
1	<p>iViewGT™ IMRT Verification Software License This software expands existing iViewGT functions to verify multiple segment beams for IMRT. The iViewGT image acquisition is triggered automatically and the image taken depends on whether the user selects single, multiple or movie image.</p>
1	<p>Template Matching Software License The template matching option enables the user to compare the portal image with a nominated reference image for any set-up error. The set-up error is measured by matching visible anatomy and the field edge on the referenced image with the portal image. The user can move the templates to provide an image displacement.</p>
1	<p>Patient Auto Select Software License This enables the prescription selected on the Linac to automatically select or create that patient record on iViewGT™ or iViewC™ using the iCom-Vx protocol. In addition, images will automatically be acquired and stored in the iViewGT / iViewC database without further operator intervention.</p>
1	<p>Software License Image Approval This allows the user, assigned with the 'review' permission, to approve or disapprove any image within iViewGT™ or iViewC™.</p>
1	<p>Las Vegas Calibration Phantom The Las Vegas phantom is a device that is used to check image quality of a portal imaging device at different megavoltage energies both at acceptance and as part of the corrective maintenance procedure.</p>
1	<p>HexaPOD™ evo RT System with iGUIDE® 2.2 The system consists of:</p> <ul style="list-style-type: none"> • HexaPOD evo RT Couchtop with homogeneous carbon fiber couchtop • Handheld controller • iBEAM evo Extension 750 long • iBEAM evo Extension 415 • iBEAM Indexing bars • iGUIDE Reference Frame • EnableSwitch board • iGUIDE workstation • iGUIDE 2.2 software • iGUIDE tracking system • iGUIDE terminal • iGUIDE calibration Kit MIMI
1	<p>HexaPOD™ evo RT System Integration License This license package will provide the following integration features:</p> <ul style="list-style-type: none"> • Interface to MOSAIQ for automated patient ID and treatment site loading for departments using MOSAIQ 2.5 or higher. • Control of Precise Table with iGUIDE for Systems with Integrity 3.2.
1	<p>iBEAM® evo Extension 650 The iBEAM evo Extension 650 is designed to support the patients upper body and extends off the end of the iBEAM evo Couchtop by 650 mm, thus allowing for treatment of the prostate of very tall patient's.</p>
1	<p>Coded shadow tray assembly - Short Provides a means for attaching X-ray shadow blocks onto the head of the Linear Accelerator or Simulator. Comprising:</p> <ul style="list-style-type: none"> • Shadow tray assembly with hook and latch mounting, and multi-way plug connector • Two removable parallel transparent Perspex™ trays, one of which may be coded.
1	<p>Beam Block Tray - Star Pattern Lexan beam block tray with holes in a star pattern. Trays are designed with threaded, removable plugs for the coding of each block. Specially designed for use with the Elekta shadow tray assembly.</p>
1	<p>Hook and Latch Magnification Graticule Solid Frame Port Film magnification graticule that attaches directly to the linac, taking the place of the coded shadow tray, thus providing more clearance between the patient and the accessory. Used in treatment verification for situations where simultaneous fitment of blocking tray is not required.</p>

Qty	Description
1	<p>Electron Beam Field Shaping System For use with Electron applicators from Elekta and allows the user to easily provide Electron Beam field shaping. The system comprises:</p> <ul style="list-style-type: none"> • A Universal leveling template with an adjustable arm for securing styro-foam inserts- Set of five (5) rubber molds compatible with Elekta Electron applicators <ul style="list-style-type: none"> • 6cm x 6cm • 10cm x 10cm • 14cm x 14cm • 20cm x 20cm • 25cm x 25cm <p>Provided as part of the system is one (1) Hot Wire Cutter.</p>
5	<p>19-inch Control Room LCD Monitor</p>
1	<p>Extender Cards Extender cards for fault diagnosis on the Electrical Interface Module (EIM).</p>
1	<p>Customer Interface Terminal Board</p>
1	<p>Turbo Starter Kit for Linear Accelerators Ancillary equipment required for the installation and maintenance of any Precise Digital Accelerator. Comprising:</p> <ul style="list-style-type: none"> • Rotary vacuum pump • Turbo molecular pump attachment for rapid pump down times and higher roughing vacuum.
1	<p>Room Lasers, Green, Remote Set of 4 green room lasers with remote control adjustment. Comprising 3 crosshair and 1 line sagittal laser. Featuring fine lines (< 1mm), high precision adjustment at the isocenter and stable mounting bracket. Inclusive of switchable (110v to 240v) power supply and universal main adaptor.</p>
1	<p>Applications Training for Standard Therapy on the Desktop The 2-day Standard Precise Desktop Course (travel time inclusive) provides training for 4 Radiation Therapists in the clinical use of the Precise Desktop Digital Linear Accelerator. Successful participants will be equipped with the knowledge and skills to operate the system effectively. The course does not provide training in the principles or techniques used in Radiation Therapy.</p>
1	<p>Applications training for iViewGT™ The 3-day iViewGT training course (travel time inclusive), provides training for 4 radiation therapists in the clinical use of the iViewGT imaging system. Successful participants will be equipped with the knowledge and skills to operate the system effectively. The course does not provide training in the principles or techniques used in radiation therapy.</p>
1	<p>XVI Applications Training The 4-day XVI training course (travel time inclusive) provides training for Radiation Therapists in the clinical use of the X-ray Volume Imaging portion of the Elekta Digital Accelerators. Successful participants will be equipped with the knowledge and skills to operate the system effectively. The course does not provide training in the principles or techniques used in Radiation Therapy, CT, or Diagnostic Imaging. This course is given at the customer site for a maximum of 4 users.</p>
1	<p>HexaPOD™ evo RT System Training The 2-day HexaPOD evo RT CouchTop and iGUIDE® course (travel inclusive) provides training for 4 radiation therapists in the clinical use of the HexaPOD evo RT CouchTop and iGUIDE software. Successful participants will be equipped with the knowledge and skills to operate the system effectively. The course does not provide training in the principles or techniques used in radiation therapy.</p>
1	<p>Linac Labor Warranty</p>

Qty	Description
1	<p>Weekend Rigging & Handling Basic rigging of Linac to first floor or ground floor location outside of Elekta's normal working hours. Elekta will provide the necessary crew to offload, uncrate, rigging and machinery moving required to set system as per plan, and remove debris. Basic rigging excludes use of a crane or rigging down an elevator shaft. Standard Rigging includes:</p> <ul style="list-style-type: none"> • Make one pre-installation site visit and delivery project management. • Drill holes for equipment fasteners • Supply a 12,000 lb capacity forklift during the off loading procedure. • Stage and uncrate the linac machine, move all components into the facility, and set as directed. • Remove and dispose of all packaging that will not be reused. • Transport the base, gantry and beam arm into the facility/bunker on transport trolleys supplied by Elekta. • Set the base frame in place (Elekta will level). • Set the gantry drum onto the base frame. • Set beam arm into the gantry. • Install counterweight holder and stack the counterweights. • Supply a manual gantry lifting system to perform aforementioned setting activities and all necessary tools. • Supply a crew, including a rigging supervisor. • Include the cost of all associated resource and expenses, including related travel time. • Complete all rigging activities in a single day. <p>Standard Rigging excludes:</p> <ul style="list-style-type: none"> • Crane service. • Elevator, or shaft deliveries. • No clear access to the building (exterior). • Interior obstruction en route to treatment room. • Any shoring needed to protect the structure from the weight of the system. • Any shoring and/or plating needed to build temporary dock or landing area for the unit. • Extra long delivery routes, distances in excess of 150' from offload site to the treatment room. • Overtime, weekend, premium time, unless Weekend Rigging selected. • Additional travel expenses should the project exceed the time allotted in this scope for reasons beyond Elekta or our contractor's control. • Additional man-hours, manpower, travel expenses, or equipment required due to delays caused by incorrect site preparation, waiting time, or delays not caused by Elekta or our contractor will be itemized and billed to the customer at then current rates.
1	<p>iViewGT™ Amorphous Silicon detector panel for production systems.</p>
1	<p>Drayage</p>
1	<p>Linac Installation</p>
1	<p>Open Air Graticule The Open Air Graticule is intended to be used for Radiation Therapy to project a scale of defined increments on port film images which can aid in treatment setup and verification. The Open Air Graticule does not require the use of a shadow tray holder and can be attached directly to the head of the Precise Treatment System or SL Linac. It consists of two wires delineating the X & Y axis of the treatment field. This model of graticule is ideal for MLC customers and especially those using Elekta's iView & iViewGTTM. Because the open air graticule has a minimal transmission factor, with Physic's approval, the customer does not have to re-enter the treatment room after the port film to deliver the treatment. Please see product User manual for specific treatment information.</p>
6	<p>Education & Training Travel Support (4-6 day course) Elekta will provide reasonable and necessary travel to support completion of the Off-Site Education & Training course(s) purchased under this Agreement. This Travel Support includes reasonable and necessary airfare and accommodations booked at least three (3) weeks in advance through Elekta's approved travel agent, proof of course registration at the time of booking is required. Extended airfare and accommodations beyond the duration required to travel and attend the course(s) is not permitted. This Travel Support also includes reasonable and necessary local transportation costs and up to \$100 (USD) per person per day to cover reasonable and necessary meals, which will be paid by Elekta directly to Customer (not to Customer employees) upon receipt of invoice, proof of course completion and supporting receipts. This Travel Support is available for up to two (2) years after date of Acceptance, no exceptions permitted. Price - \$2,000.00 USD (ea)</p>
1	<p>Control System hardware for XVI R5.0.4 The XVI control system is a high specification PC which supports all aspects of the IGRT process including 2D, 3D and 4D kV image acquisition, reconstruction, and analysis using a suite of registration functionality.</p>
1	<p>XVI 5.0.4 Software Licenses</p>

Qty	Description
1	<p>Elekta Versa HD™ - Optional XVI Cassettes Provision of additional XVI collimators, in Elekta Versa HD colours, for Imaging. Includes:</p> <ul style="list-style-type: none"> • VolumeView cassettes: L10, M2, L2 • XVI Cassette holder.
1	<p>Closed Circuit TV System - Color The standard CCTV system consists of two Samsung SNP-5321 (1.3 Megapixel HD) dome-shaped color cameras and two pan/tilt/zoom control mounts allowing the operator full control of both cameras.</p>
1	<p>Intercom system for patient and radiographer communication The ASK-4® 501-TLI-CF is a single zone audio monitoring system with 2-way talk/listen capabilities. It consists of a remote speaker/microphone and audio base station with built-in microphone and speaker.</p>
1	<p>Medical Gases SF6 for Installation and Service Includes:</p> <ul style="list-style-type: none"> • Cylinder • Regulator • Delivery
1	<p>Medical Gases Nitrogen for Installation and Service Includes:</p> <ul style="list-style-type: none"> • Cylinder • Regulator • Delivery
2	<p>Elekta Linear Accelerator Physics Objective After completing this course, attendees will:</p> <ul style="list-style-type: none"> • Identify different components of an Elekta linear accelerator. • Operate the linear accelerator's controls. • Summarize the system communication and the different protocols used. • Operate the accelerator in service and clinical modes. • Perform calibration of dosimetry system. • Understand fundamentals of MLC control system, optical tracking, and calibration. • Outline the operation of imaging systems for IGRT and perform basic quality assurance. <p>Course Content</p> <ul style="list-style-type: none"> • Theory of Operation • Control Sytem and System Communication • Beam Measurement and Dosimetry • Agility Beam Limiting Device • Imaging Systems and Introduction to IGRT <p>The application has been made to CAMPEP for 31.2 Medical Physics Continuing Education Credits (MPCEC.)</p> <p>Duration 5-day training at Elekta's Region North America LINC</p> <p>Target Group</p> <ul style="list-style-type: none"> • Medical Physicists • Medical Physics Students <p>Pre-requisites None</p>

Qty	Description
2	<p>Medical Accelerator Quality Assurance After completing this course, attendees will:</p> <ul style="list-style-type: none"> List all AAPM TASK GROUP 142 REPORT report tests and their recommended frequency. Perform Dosimetry, mechanical, safety, respiratory gating, universal wedge, MLC, and imaging tests and evaluate results of these tests. Evaluate all AAPM TG 142 report tests and determine applicability of each test to their clinical setting. Analyze potential causes of test failures in order to assist in determining necessary corrective actions in conjunction with Elekta and/or Field System Engineer. List Elekta linear accelerator characteristics and how they apply to TASK GROUP 142 REPORT accelerator QA. <p>Course Content</p> <ul style="list-style-type: none"> During this course, participants will learn about the philosophy and purpose of the recommendations given in the AAPM TASK GROUP 142 REPORT report: Quality assurance of medical accelerators. The recommended tests listed in the AAPM TASK GROUP 142 REPORT report will be presented and evaluated during this course in order for medical physicist to understand the clinical rational of each test, evaluate the necessity of each test for their specific clinical setting, and how to execute the tests in their clinical setting. The application has been made to CAMPEP for Medical Physics Continuing Education Credits (MPCEC). <p>Duration 3-day training at Elekta's Region North America LINC</p> <p>Target Group Certified Medical Physicists Medical Physics Students</p> <p>Pre-requisites Physics 1 : Medical Accelerator Introduction</p>
2	<p>Volumetric Modulated Arc Therapy (VMAT) QA Objectives After completing this course, attendees will:</p> <ul style="list-style-type: none"> Explain the clinical rational for the VMAT treatment technique. Evaluate the key factors influencing the quality of VMAT plans. List advantages and limitations of VMAT treatment technique. Explain the method by which VMAT is delivered by an Elekta linear accelerator. List the constraints required by the delivery system to ensure optimal treatment planning. Evaluate which aspects of VMAT must be tested prior to clinical use. Perform Picket Fence with Gantry Rotation, synchronization of dose rate and gantry speed, and synchronization of dose rate and MLC speed tests to evaluate proper performance of the Elekta medical accelerator. Develop and execute commissioning benchmark tests to determine baseline system performance for routine quality control testing post future repairs, upgrades, or cal checks. Discuss implementation strategies for patient specific measurement to determine gamma pass rate of the delivered plan. <p>Content During this one-day course, attendees will learn the rationale for VMAT as a treatment technique and the different methods for creating VMAT treatment plans. The course will also cover VMAT delivery, commissioning, and quality assurance for the Elekta medical accelerator as well as advantages and limitations for VMAT as a treatment technique. The application has been made to CAMPEP for 7.75 Medical Physics Continuing Education Credits (MPCEC).</p> <p>Duration 1 day</p> <p>Target Audience</p> <ul style="list-style-type: none"> Certified Medical Physicists Medical physics students <p>Prerequisites</p> <ul style="list-style-type: none"> Physics 1: Medical Accelerator Introduction Quality Assurance of Elekta Medical Accelerators.
1	<p>A Frame for Installation/Service Includes:</p> <ul style="list-style-type: none"> A Frame Trolley Hoist (pulley) <p>Delivery Note: Not required if iBeam is in place.</p>

Qty	Description
1	480VAC INPUT TRANSFORMER ONLY SYSTEM
1	Software Media Kit, Integrity 4.0.5
1	MRT 29661 SHFR400 KV GENERATOR MAINS FILTER ASSEMBLY
1	Control system CCP
1	Pre-install cable kits
1	<p>Elekta Linac Onsite Applications Training/Support Onsite applications training follow up and/or applications support for the Elekta Linac. An Elekta Applications Specialist will review Elekta Linac workflows with staff, give workflow recommendations, and help address any problem areas. Target Audience: Maximum of 6 users: Radiation Therapists, Medical Physicists, Radiation Oncologist Duration: 2 days Location: Customer site</p>
2	<p>Elekta Stereotactic Radiosurgery and Stereotactic Body Radiotherapy Physics Course During this 4-day course, participants will learn the physics behind the operation of an Elekta Medical Accelerator with Agility MLC, APEX MLC, and Stereotactic Cones. Students will build on the principles of operation of the accelerator as addressed in Elekta Medical Accelerator Physics 1 and the quality assurance aspects taught in Elekta Machine QA. Students will learn about the principles of each of the systems in regards to their Commissioning, Quality Assurance and Application for SRS and SBRT. Objectives After completing this course, attendees will:</p> <ul style="list-style-type: none"> • Be able to accept, commission and QA the SRS/SBRT solution • Perform small field dosimetry • Perform commissioning measurements • Describe the relationship of various isocenters in the accelerator • Perform Winston Lutz tests • Explain patient immobilization options • Describe IGRT options for patient positioning verification • Explain appropriate routine QA tests • Perform End to End testing • Understand requirements of AAPM TG54, TG 101 and ASTRO Target Safety reports <p>Target Audience</p> <ul style="list-style-type: none"> • Certified Medical Physicists • Medical Physics students <p>Prerequisites</p> <ul style="list-style-type: none"> • Physics 1: Medical Accelerator Introduction <p>Pricing Includes</p> <ul style="list-style-type: none"> • Tuition for one student <p>Pricing Does Not Include</p> <ul style="list-style-type: none"> • Airfare • Hotel • Travel-related expenses <p>Your eligibility for this course expires:</p> <ul style="list-style-type: none"> • Purchased with new equipment - twenty-four (24) months after Acceptance or first clinical use, whichever occurs first. • Purchased directly - 24 months after Purchase Order is accepted.
1	MONACO MASTER BEAM MODELS
1	Linac removal & destruction by 3rd party.

Qty	Description
1	<p>Elekta Linear Accelerator Physics Training This course will cover the Theory of Operation, Control System and System Communication, Beam Measurement and Dosimetry, Agility Beam Limiting Device, Imaging Systems and Introduction to IGRT on the Medical Accelerator.</p>
1	<p>Medical Accelerator Quality Assurance Training During this course, participants will learn about the philosophy and purpose of the recommendations given in the AAPM TASK GROUP 142 REPORT report: Quality assurance of medical accelerators.</p>
1	<p>Volumetric Arc Therapy Quality Assurance Training During this course, attendees will learn the rationale for VMAT as a treatment technique and the different methods for creating VMAT treatment plans. The course will also cover VMAT delivery, commissioning, and quality assurance for the Elekta medical accelerator as well as advantages and limitations for VMAT as a treatment technique.</p>
1	<p>iViewGT Linac Specific Activation License – DOSIsoft This license is required to enable connectivity with iViewGT and is licensed per iViewGT workstation.</p>
1	<p>In Room Optical Kit</p>
1	<p>XVI Advanced Imaging Symmetry Training (Online) This course is delivered 100% online as a virtual instructor led training. Users will learn how to create XVI Symmetry presets, prepare reference images for Symmetry, acquire Symmetry scans, and register Symmetry scans. This will be an interactive hands-on course that utilizes an Elekta XVI training database for practice exercises. Users will also have access to additional clinical educational content from Elekta Clinical Partners. Target Audience: Radiation Therapists, Medical Physicists, Radiation Oncologist Duration: Online virtual instructor led training sessions will be delivered as 2, 1 hour sessions. Location: Online</p>
1	<p>HexaPOD evo - Universal Camera Mount - Kit The Universal Camera Mount is part of the HexaPOD evo RT System and will be shipped from the service warehouses. The independent shipment from the warehouses enables a pre-installation of the UCM if required.</p>

CONNECTIVITY, MONITORING AND REMOTE ACCESS DURING WARRANTY

For Linac:

In order to provide the warranty for the Products, the Customer agrees to provide dedicated high-speed broadband internet connections suitable to establish a remote connection to the necessary components including but not limited to Linac and associated components and facilitate the realization of the required remote infrastructure, as agreed by the Parties.

If the Customer fails to provide the access described in this section and so the solution is not connected to Elekta IntelliMax[®] or equivalent Elekta approved solution (including any temporary disconnection), the Customer waives its rights to receive services and any uptime guarantees.

IntelliMax Agent software is installed on a standalone workstation or virtual machine. The IntelliMax Agent communicates with applicable products and acts as a gateway to the IntelliMax Enterprise (outbound via the internet). More than one IntelliMax Agent may be required for full connectivity. For more information see Elekta IntelliMax[®] Security Information, available from your Elekta representative.

Should remote access to the desktop of the device be reasonably necessary, IntelliMax Connect allows for either attended (mandatory for treatment machines) or unattended access (configurable during installation for software systems). Access via

Elekta IntelliMax[®], and details of any files transferred are recorded in an audit log which is available on upon request for a period of 12 months after the transfer.

The Customer acknowledges and agrees that notwithstanding the provisions contained in Customer's Elekta Purchase and License Agreement, Elekta shall have the ability to remotely monitor Elekta supplied systems on the Customers network via Elekta IntelliMax[®] to gain information and aid in diagnosis and correction of system issues. Remote Access/screen sharing, is configurable separately and can be set to only allow visibility of the customer's screens when initiated by the customer.